

# Panasonic®

## Digital Video Camcorder Operating Instructions

Digital Palmcorder®  
MultiCam™ Camcorder

(PV-GS15 Shown)

Models No. **PV-GS9**  
**PV-GS12**  
**PV-GS14**  
**PV-GS15**

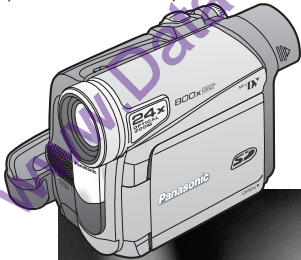

Before attempting to connect, operate or adjust this product, please read these instructions thoroughly.

**Spanish Quick Use Guide is included.**

**Guía para rápida consulta en español está incluida.**

**MultiMediaCard™**

[For PV-GS12/PV-GS14/  
PV-GS15]



[For PV-GS12/PV-GS14/  
PV-GS15]

Mini

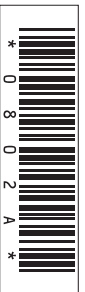

For assistance, please call : 1-800-211-PANA(7262) or, contact us via the web at: <http://www.panasonic.com/contactinfo>

LSQT0802 A

## Things You Should Know

### Thank you for choosing Panasonic!

You have purchased one of the most sophisticated and reliable products on the market today. Used properly, we're sure it will bring you and your family years of enjoyment. Please take time to fill in the information on the right.

The serial number is on the tag located on the underside of your Camcorder. Be sure to **retain this manual** as your convenient Camcorder information source.

Date of Purchase \_\_\_\_\_

Dealer Purchased From \_\_\_\_\_

Dealer Address \_\_\_\_\_

Dealer Phone No. \_\_\_\_\_

Model No. \_\_\_\_\_

Serial No. \_\_\_\_\_



## Safety Precautions

### WARNING :

**TO PREVENT FIRE OR SHOCK HAZARD, DO NOT EXPOSE THIS EQUIPMENT TO RAIN OR MOISTURE.**

Your <sup>Mini</sup> DV Camcorder is designed to record and play back in Standard Play (SP) mode and Long (LP) mode.

It is recommended that only cassette tapes that have been tested and inspected for use in VCR machines with the <sup>Mini</sup> DV mark be used.

 <b>CAUTION</b> RISK OF ELECTRIC SHOCK DO NOT OPEN		This symbol warns the user that uninsulated voltage within the unit may have sufficient magnitude to cause electric shock. Therefore, it is dangerous to make any kind of contact with any inside part of this unit.
<b>CAUTION: TO REDUCE THE RISK OF ELECTRIC SHOCK, DO NOT REMOVE COVER (OR BACK) NO USER-SERVICEABLE PARTS INSIDE REFER SERVICING TO QUALIFIED SERVICE PERSONNEL</b>		This symbol alerts the user that important literature concerning the operation and maintenance of this unit has been included. Therefore, it should be read carefully in order to avoid any problems.

The above markings are located on the appliance bottom cover.

### Declaration of Conformity

**Trade Name :** Panasonic  
**Model No. :** PV-GS9/PV-GS12/PV-GS14/PV-GS15  
**Responsibility Party :** Matsushita Electric Corporation of America  
**Address :** One Panasonic Way Secaucus New Jersey 07094  
**Telephone Number :** 1-800-211-PANA(7262)

This device complies with Part 15 of the FCC Rules. Operation is subject to the following two conditions:  
(1) This device may not cause harmful interference, and (2) this device must accept any interference received, including interference that may cause undesired operation.

### FCC Note:

This equipment has been tested and found to comply with the limits for a Class B digital device, pursuant to Part 15 of the FCC Rules. These limits are designed to provide reasonable protection against harmful interference in a residential installation. This equipment generates, uses, and can radiate radio frequency energy and, if not installed and used in accordance with the instructions, may cause harmful interference to radio communications. However, there is no guarantee that interference will not occur in a particular installation. If this equipment does cause harmful interference to radio or television reception, which can be determined by turning the equipment off and on, the user is encouraged to try to correct the interference by one or more of the following measures:

- Reorient or relocate the receiving antenna.
- Increase the separation between the equipment and receiver.
- Connect the equipment into an outlet on a circuit different from that to which the receiver is connected.
- Consult the dealer or an experienced radio/TV technician for help.

### FCC Caution:

To assure continued compliance, follow the attached installation instructions and use only shielded interface cables when connecting to computer or peripheral devices.

Any changes or modifications not expressly approved by the party responsible for compliance could void the user's authority to operate this equipment.

## CAUTION:

**TO PREVENT FIRE OR SHOCK HAZARD AND ANNOYING INTERFERENCE, USE THE RECOMMENDED ACCESSORIES ONLY.**

## CAUTION:

**TO PREVENT ELECTRIC SHOCK, MATCH WIDE BLADE OF PLUG TO WIDE SLOT, FULLY INSERT.**

## CAUTION:

**DANGER OF EXPLOSION IF BATTERY IS INCORRECTLY REPLACED. REPLACE ONLY WITH THE SAME OR EQUIVALENT TYPE.**

- Since this product gets hot during use, operate it in well ventilated place; do not install this equipment in a confined space such as a bookcase or similar unit.

## WARNING

**AS WITH ANY SMALL OBJECT, SD CARDS CAN BE SWALLOWED BY YOUNG CHILDREN. DO NOT ALLOW CHILDREN TO HANDLE THE SD CARD.**

**Panasonic** PV-GS9/PV-GS12/  
PV-GS14/PV-GS15



Tested To Comply  
With FCC Standards

FOR HOME OR OFFICE USE

## U.S.A. CONSUMERS: ATTENTION:



A lithium ion/polymer battery that is recyclable powers the product you have purchased. Please call 1-800-8-BATTERY for information on how to recycle this battery.

# Important Safeguards

1. **Read Instructions** — All the safety and operating instructions should be read before the unit is operated.
2. **Retain Instructions** — The safety and operating instructions should be retained for future reference.
3. **Heed Warnings** — All warnings on the unit and in the operating instructions should be adhered to.
4. **Follow Instructions** — All operating and maintenance instructions should be followed.
5. **Cleaning** — Unplug this video unit from the wall outlet before cleaning. Do not use liquid or aerosol cleaners. Use a dry cloth for cleaning.
6. **Attachments** — Do not use attachments not recommended by the video product manufacturer as they may be hazardous.
7. **Water and Moisture** — Do not use this video unit near water — for example near a bath tub, wash bowl, kitchen sink, or laundry tub, in a wet basement, or near a swimming pool, and the like.
8. **Accessories** — Do not place this video unit on an unstable cart, stand, tripod, bracket, or table. The video unit may fall, causing serious injury to a child or adult, and serious damage to the unit. Use only with a cart, stand, tripod, bracket, or table recommended by the manufacturer, or sold with the video unit. Any mounting of the unit should follow the manufacturer's instructions and should use a mounting accessory recommended by the manufacturer. An appliance and cart combination should be moved with care. Quick stops, excessive force, and uneven surfaces may cause the appliance and cart combination to overturn.
9. **Ventilation** — Slots and openings in the cabinet are provided for ventilation and to ensure reliable operation of the video unit and to protect it from overheating. These openings must not be blocked or covered. Never place the video unit on a bed, sofa, rug, or other similar surface, or near or over a radiator or heat register. This video unit should not be placed in a built-in installation such as a bookcase or rack unless proper ventilation is provided or the manufacturer's instructions have been adhered to.
10. **Power Sources** — This video unit should be operated only from the type of power source indicated on the marking label. If you are not sure of the type of power supply to your home, consult your appliance dealer or local power company. For video units intended to be operated from battery power, or other sources, refer to the operating instructions.



11. **Grounding or Polarization** — This video unit may be equipped with either a polarized 2-wire AC (Alternating Current) line plug (a plug having one blade wider than the other) or 3-wire grounding type plug, a plug having a third (grounding) pin.

The 2-wire polarized plug will fit into the power outlet only one way. This is a safety feature. If you are unable to insert the plug fully into the outlet, try reversing the plug. If the plug still fails to fit, contact your electrician to replace your obsolete outlet. Do not defeat the safety purpose of the polarized plug.

The 3-wire grounding type plug will fit into a grounding type power outlet. This is a safety feature. If you are unable to insert the plug into the outlet, contact your electrician to replace your obsolete outlet. Do not defeat the safety purpose of the grounding type plug.

12. **Power-Cord Protection** — Power-supply cords should be routed so that they are not likely to be walked on or pinched by items placed upon or against them, paying particular attention to cords of plugs, convenience receptacles, and the point where they exit from the unit.
13. **Outdoor Antenna Grounding** — If an outside antenna or cable system is connected to the video unit, be sure the antenna or cable system is grounded so as to provide some protection against voltage surges and built-up static charges. Part 1 of the Canadian Electrical Code, in USA Section 810 of the National Electrical Code, provides information with respect to proper grounding of the mast and supporting structure, grounding of the lead-in wire to an antenna discharge unit, size of grounding conductors, location of antenna discharge unit, connection to grounding electrodes, and requirements for the grounding electrode.

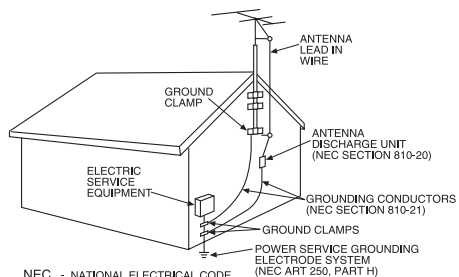

14. **Lightning** — For added protection of this video unit receiver during a lightning storm, or when it is left unattended and unused for long periods of time, unplug it from the wall outlet and disconnect the antenna or cable system. This will prevent damage to the video unit due to lightning and power-line surges.

15. Power Lines — An outside antenna system should not be located in the vicinity of overhead power lines or other electric light or power circuits, or where it can fall into such power lines or circuits. When installing an outside antenna system, extreme care should be taken to keep from touching such power lines or circuits as contact with them might be fatal.
16. Overloading — Do not overload wall outlets and extension cords as this can result in a risk of fire or electric shock.
17. Objects and Liquids — Never push objects of any kind into this video unit through openings as they may touch dangerous voltage points or short out parts that could result in a fire or electric shock. Never spill liquid of any kind onto the video unit.
18. Servicing — Do not attempt to service this video unit yourself as opening or removing covers may expose you to dangerous voltage or other hazards. Refer all servicing to qualified service personnel.
19. Damage Requiring Service — Unplug this video unit from the wall outlet and refer servicing to qualified service personnel under the following conditions:
  - a. When the power-supply cord or plug is damaged.
  - b. If any liquid has been spilled into, or objects have fallen onto, the video unit.
  - c. If the video unit has been exposed to rain or water.
  - d. If the video unit does not operate normally by following the operating instructions. Adjust only those controls that are covered by the operating instructions, as an improper adjustment of other controls may result in damage and will often require extensive work by a qualified technician to restore the video unit to its normal operation.
  - e. If the video unit has been dropped or the cabinet has been damaged.
  - f. When the video unit exhibits a distinct change in performance — this indicates a need for service.
20. Replacement Parts — When replacement parts are required, be sure the service technician has used replacement parts specified by the manufacturer or have the same characteristics as the original part. Unauthorized substitutions may result in fire, electric shock or other hazards.
21. Safety Check— Upon completion of any service or repairs to this video unit, ask the service technician to perform safety checks to determine that the video unit is in safe operating order.

## Precautions

### WARNING

#### USE & LOCATION

- **TO AVOID SHOCK HAZARD ...** Your Camcorder and power supply should not be exposed to rain or moisture. Do not connect the power supply or operate your Camcorder if it gets wet. Your Camcorder has been designed for outdoor use, however, it is not designed to sustain direct exposure to water, rain, sleet, snow, sand, dust, or direct splashing from a pool or even a cup of coffee. This action could permanently damage the internal parts of your Camcorder. Do not attempt to disassemble this unit. There are no user serviceable parts inside. Unplug your Camcorder from the power supply before cleaning.

### CAUTION

- **DO NOT AIM YOUR CAMCORDER AT THE SUN OR OTHER BRIGHT OBJECTS**
- **DO NOT LEAVE THE CAMCORDER WITH THE EVF AIMED DIRECTLY AT THE SUN AS THIS MAY CAUSE DAMAGE TO THE INTERNAL PARTS OF THE EVF**
- **DO NOT EXPOSE YOUR CAMCORDER TO EXTENDED HIGH TEMPERATURE ...** Such as, direct sunlight, inside a closed car, next to a heater, etc... This action could permanently damage the internal parts of your Camcorder.
- **AVOID SUDDEN CHANGES IN TEMPERATURE ...** If the unit is suddenly moved from a cold place to a warm place, moisture may form on the tape and inside the unit.
- **DO NOT LEAVE YOUR CAMCORDER OR THE POWER SUPPLY TURNED ON WHEN NOT IN USE.**
- **STORAGE OF YOUR CAMCORDER ...** Store and handle your Camcorder in a manner that will not subject it to unnecessary movement (avoid shaking and striking). Your Camcorder contains a sensitive pick-up device which could be damaged by improper handling or storage.

#### CARE

- **TO CLEAN YOUR CAMCORDER ...** Do not use strong or abrasive detergents when cleaning your Camcorder body.
- **TO PROTECT THE LENS ...** Do not touch the surface of the lens with your hand. Use a commercial Camcorder lens solution and lens paper when cleaning the lens. Improper cleaning can scratch the lens coating.
- **TO PROTECT THE FINISH OF YOUR CAMCORDER ...** Before handling your Camcorder, make sure your hands and face are free from any chemical products, such as suntan lotion, as it may damage the finish.

Apparatus Claims of U.S. Patent Nos. 4,631,603, 4,577,216, and 4,819,098, licensed for limited viewing. This product incorporates copyright protection technology that is protected by method claims of certain U.S. patents and other intellectual property rights owned by Macrovision Corporation and other rights owners. Use of this copyright protection technology must be authorized by Macrovision Corporation, and is intended for home and other limited viewing uses only unless otherwise authorized by Macrovision Corporation. Reverse engineering or disassembly is prohibited.

---

Before opening the CD-ROM package (PV-GS15: Supplied, PV-GS9/PV-GS12/PV-GS14: Optional Software), please read the following.

## ***End User License Agreement (for USB Driver, WebCam Driver and DV STUDIO (Optional Software))***

You ("Licensee") are granted a license for the Software defined in this End User Software Agreement ("Agreement") on condition that you agree to the terms and conditions of this Agreement. If Licensee does not agree to the terms and conditions of this Agreement, promptly return the Software to Matsushita Electric Industrial Co., Ltd. ("Matsushita"), its distributors or dealers from which you made the purchase.

### **Article 1 License**

Licensee is granted the right to use the software, including the information recorded or described on the CD-ROM, instruction manuals, and any other media provided to Licensee (collectively "Software"), but all applicable rights to patents, copyrights, trademarks and trade secrets in the Software are not transferred to Licensee.

### **Article 2 Use by a Third Party**

Licensee may not use, copy, modify, transfer or allow any third party, whether free of charge or not, to use, copy or modify the Software, except as expressly provided for in this Agreement.

### **Article 3 Restrictions on Copying the Software**

Licensee may make a single copy of the Software in whole or in part solely for back-up purpose.

### **Article 4 Computer**

Licensee may only use the Software on a single computer at a single location.

### **Article 5 Reverse Engineering, Decompiling or Disassembly**

Licensee may not reverse engineer, decompile, or disassemble the Software, except to the extent either of them is permitted under law or regulation of the country where Licensee resides. Matsushita, or its distributors or dealers will not be responsible for any defects in the Software or damage to Licensee caused by Licensee's reverse engineering, decompiling, or disassembly of the Software.

### **Article 6 Limitation of Liability**

The Software is provided "AS-IS" without warranty of any kind, either expressed or implied, including, but not limited to, warranties of non-infringement, merchantability and/or fitness for a particular purpose. Further, Matsushita does not warrant that the operation of the Software will be uninterrupted or error free. Matsushita or any of its distributors or dealers will not be liable for any damage suffered by Licensee arising from or in connection with Licensee's use of the Software.

### **Article 7 Export Control**















Licensee agrees not to export or re-export to any country the Software in any form without the appropriate export licenses under regulations of the country where Licensee resides, if necessary.

### **Article 8 Termination of License**

The right granted to Licensee hereunder will be automatically terminated if Licensee violates any of the terms and conditions of this Agreement. Upon such automatic termination, Licensee must destroy the Software and related documentation together with all the copies thereof at Licensee's own expense.

This operating instruction book is designed for use with models **PV-GS9**, **PV-GS12**, **PV-GS14**, and **PV-GS15**. The **PV-GS15** is the model used for illustrative purposes. Features may vary, so please read carefully.

## Differences between models

Model Number	PV-GS9	PV-GS12	PV-GS14	PV-GS15
Battery Pack (Supplied)	CGR-D08R (800 mAh)	CGR-D08R (800 mAh)	CGR-D08R (800 mAh)	CGR-D14 (1 350 mAh)
Memory Card		Optional	Optional	Supplied (RP-SD008MMK0)
CD-ROM	Optional Software	Optional Software	Optional Software	Supplied (LSFT0575)
Remote Control	Optional	Optional	Optional	Supplied (LSSQ0411)
USB Cable	Optional	Optional	Optional	Supplied (K1HA05CD0005)
Lens	f2.1-42 mm, F1.8-3.1 (35 mm equivalent: 39.5-790 mm), 20x zoom lens	f2.1-42 mm, F1.8-3.1 (35 mm equivalent: 39.5-790 mm), 20x zoom lens	f2.1-46.2 mm, F1.8-3.4 (35 mm equivalent: 39.5-869 mm), 22x zoom lens	f2.1-50.4 mm, F1.8-3.6 (35 mm equivalent: 39.5-948 mm), 24x zoom lens
Photoshot (Tape) Feature	Yes	No	No	No
Mode Dial	 (Tape Recording Mode)  (Tape Playback Mode)	 (Tape Recording Mode)  (Tape Playback Mode)  (Card Recording Mode)  (Picture Playback Mode)	 (Tape Recording Mode)  (Tape Playback Mode)  (Card Recording Mode)  (Picture Playback Mode)	 (Tape Recording Mode)  (Tape Playback Mode)  (Card Recording Mode)  (Picture Playback Mode)
Card Feature	No	Yes	Yes	Yes
Viewfinder	Electronic Viewfinder	Electronic Viewfinder	Liquid Crystal Color Electronic Viewfinder	Liquid Crystal Color Electronic Viewfinder
LED Video Light	No	Yes	Yes	Yes
S-Video Output Jack	No	No	Yes	Yes
Microphone Jack	No	No	Yes	Yes

## Contents

### Before Use

Things You Should Know .....	2
Safety Precautions .....	2
Important Safeguards .....	4
Precautions .....	5
End User License Agreement.....	6
Differences between models .....	7
Quick Guide.....	10
Standard Accessories.....	12
Controls and Components.....	12
The Remote Control (PV-GS15 Only) .....	14
Power Supply .....	15
Charging Time and Available Recording Time...16	
How to remove the Sensor tag.....	16
The Grip Belt .....	16
Re-attaching the Lens Cap.....	17
Attaching the Shoulder Strap .....	17
Inserting a Cassette .....	17
Using a Memory Card (For PV-GS12/PV-GS14/PV-GS15).....	18
Turning on the Camcorder.....	18
Easy to Use Mode Dial.....	18
Using the Viewfinder/LCD Monitor .....	19
Using the Menu Screen .....	19
List of Menus .....	20
Setting Date and Time .....	23
Internal Lithium Battery Recharge .....	23
LP Mode .....	23
Audio Recording Mode.....	23

### Recording Mode

About Recording.....	24
Recording on a Tape .....	24
Recording a Still Picture on a Tape (PV-GS9 Only).....	25
Recording a Still Picture on a Card (Photoshot) (For PV-GS12/PV-GS14/PV-GS15).....	25
Recording Yourself .....	26
Recording with the Built-in LED Video Light (For PV-GS12/PV-GS14/PV-GS15).....	26
Quick Start.....	26
Self-timer Recording.....	27
Zoom In/Out Functions .....	27
Digital Zoom Function .....	27
Image Stabilizer Function .....	28
Fade In/Out Functions.....	28
Backlight Compensation Function.....	29
MagicPix Function .....	29
Soft-Skin Mode.....	29
Wind Noise Reduction Function .....	29
Cinema Function .....	29
Recording in Special Situations.....	30
Recording in Natural Colors .....	30
Adjusting White Balance Manually .....	31
Manual Shutter Speed Adjustment.....	32
Manual Iris Adjustment .....	32
Manual Focus Adjustment .....	32
Digital Effect Functions.....	33



---

---

## Playback Mode

Playing Back a Tape .....	35
Finding a Scene You Want to Play Back .....	35
Slow Motion Playback (Remote Control Only) ..	36
Still Playback/Still Advance Playback .....	36
Index Search Functions	
(Remote Control Only) .....	37
Playback Zoom Function	
(Remote Control Only) .....	37
Playback Digital Effect Functions .....	38
Playing Back a Memory Card	
(For PV-GS12/PV-GS14/PV-GS15) .....	38
Slide Show	
(For PV-GS12/PV-GS14/PV-GS15) .....	39
Creating a Title	
(For PV-GS12/PV-GS14/PV-GS15) .....	40
Adding a Title	
(For PV-GS12/PV-GS14/PV-GS15) .....	40
Writing Printing Data on a Card	
(For PV-GS12/PV-GS14/PV-GS15) .....	41
Protecting the Files on a Card	
(For PV-GS12/PV-GS14/PV-GS15) .....	41
Deleting the Files Recorded on a Card	
(For PV-GS12/PV-GS14/PV-GS15) .....	42
Formatting a Card	
(For PV-GS12/PV-GS14/PV-GS15) .....	42
Playing Back on Your TV .....	43

## Editing Mode

Recording from a Tape onto a Card	
(For PV-GS12/PV-GS14/PV-GS15) .....	44
Recording Pictures from a Card onto a Tape	
(For PV-GS12/PV-GS14/PV-GS15) .....	44
Audio Dubbing (Remote Control Only) .....	44
Copying on an S-VHS (or a VHS) Cassette .....	45
Using the DV Cable for Recording .....	45
PC Connection With DV Interface Cable .....	46

## With a PC

Using the Software with a Personal Computer ..	47
Using USB Driver .....	47
To disconnect USB cable safely .....	49
Using as a Web Camera .....	50
Using the DV STUDIO 3.1E-SE	
(Optional Software) .....	53
Using the ArcSoft Software	
(PV-GS15: Supplied) .....	55
If you no longer need software or driver	
(Uninstall) .....	56
Notes .....	57

## Others

Indications .....	59
Initializing the Modes .....	60
Warning/Alarm Indications .....	60
Notes and Hints .....	61
Cautions for Use .....	65
Before Requesting Service	
(Problems and Solutions) .....	69
Using the RESET button .....	70
Explanation of Terms .....	71
Specifications .....	72
Camcorder Accessory System .....	73
Camcorder Accessory Order Form .....	74
Request for Service Notice .....	75
Limited Warranty .....	76
Customer Services Directory .....	78
Spanish Quick Use Guide/ Guía Para Uso Rápido .....	79
Guía rápida .....	80
Index .....	82

## Quick Guide

- 1 Attach the Battery to the AC Adaptor and charge it.

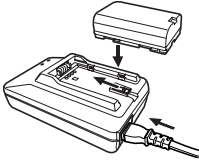

- Before use, fully charge the Battery.
- Since the Battery will not be charged when the DC Cable is connected to the AC Adaptor, disconnect it from the AC Adaptor.
- The [POWER] Lamp and [CHARGE] Lamp light up, and charging starts.
- When the [CHARGE] Lamp goes off, charging is completed.

- 2 Attach the charged Battery to the Camcorder.

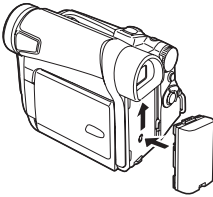

### ■ Inserting a Cassette

- 1 Slide the [OPEN/EJECT] Lever ① toward the front and pull down to fully open the Cassette Compartment Cover.

- To protect the tape, if the cover is not fully opened, the cassette cannot be ejected.

- 2 Insert a Cassette.



- 3 Close the Cassette Holder by pressing the [PUSH] mark ②.

- 4 Close the Cassette Compartment Cover by pressing the mark ③.

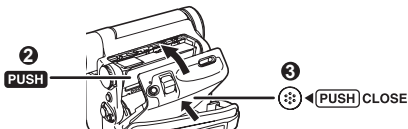

### ■ Inserting a Card

(For PV-GS12/PV-GS14/PV-GS15)

- 1 Place your Thumb on the [OPEN▼] ① Knob and pull the LCD Monitor ② out in the direction of the arrow.

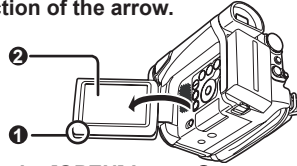

- 2 Slide the [OPEN] Lever ③ to open the Card Slot Cover ④.

- 3 While holding the Memory Card with its cut corner facing right ⑤ insert it into the Card Slot ⑥.

- 4 Close the Card Slot Cover ④ securely.

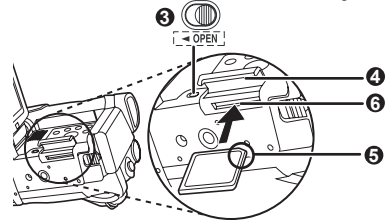

### ■ Recording on a Tape

- 1 Set the [OFF/ON] Switch ① to [ON].

- The [POWER] Lamp ② lights up.

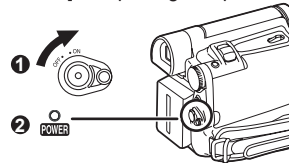

- 2 Set the Mode Dial to Tape Recording Mode.

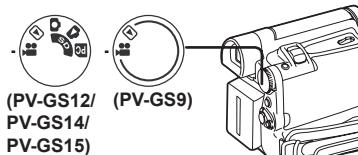

- 3 Press the Recording Start/Stop Button.

- Recording starts.

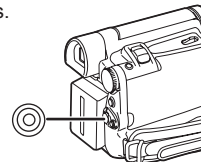

- 4 Press the Recording Start/Stop Button again to pause the recording.

■ Recording a Still Picture on Tape  
(PV-GS9 Only)

1 Set the Mode Dial to Tape Recording Mode.

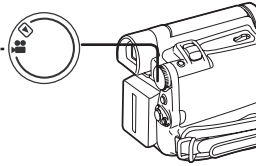

2 Press the [PHOTO SHOT] Button in the Recording Pause Mode.

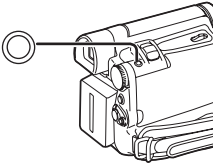

■ Recording a Still Picture on Card  
(Photoshot)  
(For PV-GS12/PV-GS14/PV-GS15)

1 Set the Mode Dial to Card Recording Mode.

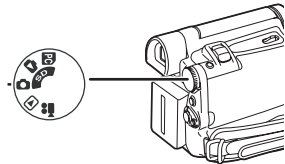

2 Press the [PHOTO SHOT] Button.

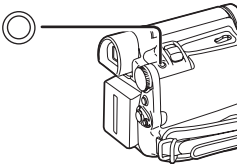

■ Playing Back a Tape

1 Set the [OFF/ON] Switch ① to [ON].

• The [POWER] Lamp ② lights up.

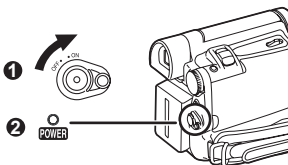

2 Set the Mode Dial to Tape Playback Mode.

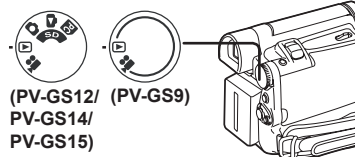

3 Press the [◀◀] Button to rewind the tape.

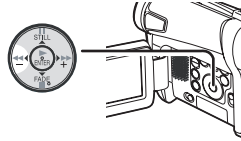

4 Press the [▶▶] Button to start playback.

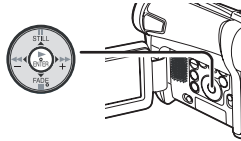

5 Press the [■] Button to stop playback.

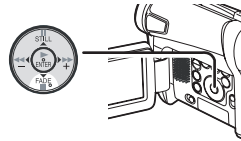

■ Playing Back a Card  
(For PV-GS12/PV-GS14/PV-GS15)

1 Set the Mode Dial to Picture Playback Mode.

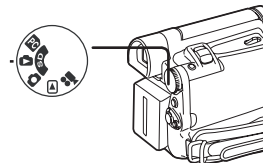







2 Start Playback.

- ▶ : Starting the Slide Show
- ▶▶ : Playing back the next picture
- ◀◀ : Playing back the previous picture
- : Stop the Slide Show
- || : Pause the Slide Show

## Before Use

### Standard Accessories

Illustrated are accessories supplied with the Camcorder.

1) 		
2) 	3) 	
4) 	5) 	6) 
7) 		

- 1) AC Adaptor, DC Cable and AC Cable (p. 15)

#### CAUTION:

This unit will operate on 110/120/220/240 V AC. An AC plug adaptor may be required for voltages other than 120 V AC. Please contact either a local or foreign electrical parts distributor for assistance in selecting an alternate AC plug. We recommend using the accessory power plug adaptor (VJSS0070/KZDB4ZE00001) in an area which has special AC outlets.

- 2) Battery Pack (p. 15)  
 3) Remote Control and Button-Type Battery (p. 14) (PV-GS15 Only)  
 4) AV Cable (pp. 43, 45)  
 5) Shoulder Strap (p. 17)  
 6) SD Memory Card (PV-GS15 Only) (p. 18)  
 7) USB Connection Kit (USB Cable and CD-ROM) (PV-GS15 Only) (pp. 47-49, 51, 54)

## Controls and Components

### ■ Camcorder

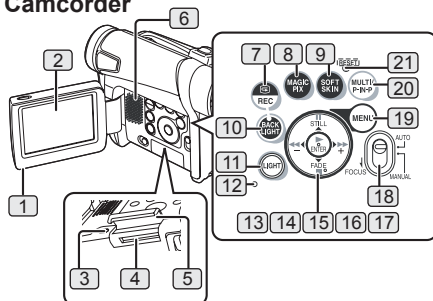

- 1) LCD Monitor Open Knob [OPEN ▼] (p. 19)  
 2) LCD Monitor (pp. 19, 68)

Due to limitations in LCD production technology, there may be some tiny bright or dark spots on the LCD Monitor screen.

However, this is not a malfunction and does not affect the recorded picture.

- 3) Card Slot Cover Open Lever [◀OPEN] (For PV-GS12/PV-GS14/PV-GS15) (p. 18)  
 4) Card Slot (For PV-GS12/PV-GS14/PV-GS15) (p. 18)  
 5) Card Slot Cover (For PV-GS12/PV-GS14/PV-GS15) (p. 18)  
 6) Speaker (p. 35)  
 7) Recording Check Button [Ⓢ] (p. 24)  
 Recording Button [REC] (p. 46)  
 8) MagicPix Button [MAGICPIX] (p. 29)  
 9) Soft Skin Button [SOFT SKIN] (p. 29)  
 10) Backlight Button [BACK LIGHT] (p. 29)  
 11) Light Button [LIGHT] (For PV-GS12/PV-GS14/PV-GS15) (p. 26)  
 12) Card Access Lamp (For PV-GS12/PV-GS14/PV-GS15) (p. 18)  
 13) Pause Button [II] (p. 25)  
 Still Button [STILL] (p. 25)  
 14) Fast Forward/Cue Button [▶▶] (p. 35)  
 15) Play Button [▶] (p. 35)  
 Enter Button [ENTER] (p. 20)  
 16) Stop Button [■] (p. 35)  
 Fade Button [FADE] (pp. 28-29)  
 17) Rewind/Review Button [◀◀] (p. 35)  
 18) Mode Selector Switch [AUTO/MANUAL/FOCUS] (pp. 24, 30-32)  
 19) Menu Button [MENU] (p. 19)  
 20) Multi Button [MULTI] (p. 33)  
 Picture-in-Picture Button [P-IN-P] (p. 34)  
 21) Reset Button [RESET] (pp. 60, 70)

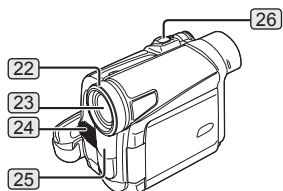

- 22 Lens Hood (p. 69)**
- 23 Lens**
- 24 Microphone (built-in, stereo) (pp. 27, 29)**
- 25 Built-in LED Light (For PV-GS12/PV-GS14/PV-GS15) (p. 26)**
- 26 Zoom Lever [W/T] (pp. 27-28, 35)**

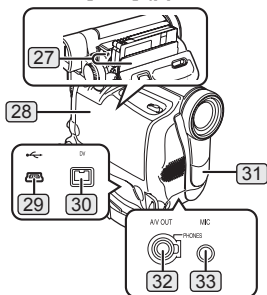

- 27 Cassette Holder**
- 28 Cassette Compartment Cover (p. 17)**
- 29 USB Jack [↔] (pp. 48-49, 51, 54)**
- 30 DV Input/Output Terminal (pp. 45-46)**
  - Connect this to the digital video equipment.
- 31 White Balance Sensor (p. 31)**
- Remote Control Sensor (p. 15)**
- 32 Audio-Video Output Jack [AV OUT] (pp. 43, 45)**
- Headphone Jack [PHONES]**
  - Connecting an AV Cable to this jack activates the Camcorder's built-in speaker, but connecting a headphone, etc. deactivates it.
  - When connecting the pin plug of the AV Cable to this jack, plug it in as far as it goes.
  - When using headphones, set [INITIAL] >> [AV JACK] >> [OUT/PHONES].
- 33 Microphone Jack [MIC] (For PV-GS14/PV-GS15)**
  - When connecting an external microphone or audio equipment to this jack, the built-in microphone does not operate.
  - A compatible plug-in powered microphone can be used. Please consult your dealer for more information.
  - The microphone may make noises depending on the type used. In this case, we recommend using the battery with the Camcorder to reduce noises instead of the AC Adaptor.

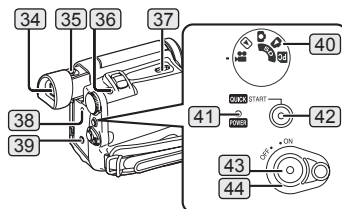

- 34 Viewfinder (pp. 19, 68)**

Due to limitations in LCD production technology, there may be some tiny bright or dark spots on the Viewfinder screen. However, this is not a malfunction and does not affect the recorded picture.

- 35 Eyepiece Corrector Knob (p. 19)**
- 36 Photoshot Button [PHOTO SHOT] (pp. 25-26)**
- 37 Cassette Eject Lever [OPEN/EJECT] (p. 17)**
- 38 DC Input Jack [DC IN] (p. 15)**
- 39 S-Video Output Jack [S-VIDEO OUT] (For PV-GS14/PV-GS15) (pp. 43, 45)**
- 40 Mode Dial (p. 18)**
- 41 Power Lamp [POWER] (p. 18)**
- 42 Quick Start Recording Button [QUICK START] (p. 26)**
- Quick Start Recording Lamp (p. 26)**
- 43 Recording Start/Stop Button (p. 24)**
- 44 Power Switch [OFF/ON] (pp. 18, 24)**

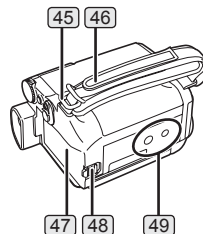

- 45 Shoulder Strap Holders (p. 17)**
- 46 Grip Belt (p. 16)**
- 47 Battery Holder**
- 48 Battery Eject Switch [BATTERY RELEASE] (p. 16)**
- 49 Tripod Receptacle**
  - Used for mounting the Camcorder on an optional tripod.

## Remote Control (PV-GS15 Only)

Using the wireless Remote Control with the Camcorder, most of the Camcorder functions can be operated from a distance.

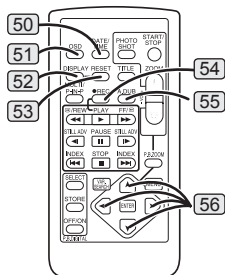

- 50 Date/Time Button [DATE/TIME] (p. 60)
- 51 Indication Output Button [OSD] (p. 43)
- 52 Display Button [DISPLAY] (p. 60)
- 53 Reset Button [RESET] (pp. 60, 70)
- 54 Recording Button [● REC] (p. 45)
- 55 Audio Dubbing Button [A.DUB] (p. 44)
- 56 Cursor Buttons for Variable Speed Search Function [▲, ▼] (p. 36)  
Direction Buttons for Playback Zoom Function [▲, ▼, ◀, ▶] (p. 37)

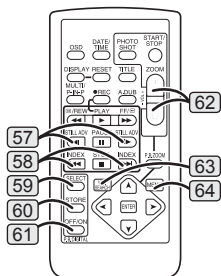

- 57 Slow Motion/Still Advance Buttons [◀|, |▶] (◀|: reverse, |▶: forward) (p. 36)
- 58 Index Search Buttons [◀◀, ▶▶] (◀◀: reverse, ▶▶: forward) (p. 37)
- 59 Selection Button [SELECT] (p. 38)
- 60 Store Button [STORE] (p. 38)
- 61 Off/On Button [OFF/ON] (p. 38)
- 62 Zoom/Volume Button [ZOOM/VOL] (p. 38)
- 63 Variable Speed Search Button [VAR.SEARCH] (p. 36)
- 64 Menu Button [MENU] (p. 19)

The following buttons function in the same manner as the corresponding buttons on the Camcorder.

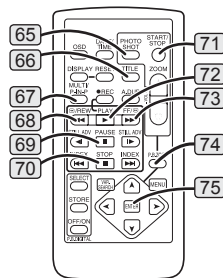

- 65 Photoshot Button [PHOTO SHOT] (pp. 25-26)
- 66 Title Button [TITLE] (p. 40)
- 67 Multi-Picture/Picture-in-Picture Button [MULTI/P-IN-P] (pp. 33-34)
- 68 Rewind/Review Button [◀◀] (p. 35)
- 69 Pause Button [II] (pp. 36, 44-45)
- 70 Stop Button [■] (pp. 37, 45)
- 71 Recording Start/Stop Button [START/STOP] (p. 24)
- 72 Play Button [▶] (pp. 36, 45)
- 73 Fast Forward/Cue Button [▶▶] (p. 35)
- 74 Playback Zoom Button [P.B. ZOOM] (p. 37)
- 75 Enter Button [ENTER] (p. 20)

## The Remote Control (PV-GS15 Only)

### Inserting the Button-type Battery

Before using the Remote Control, insert the supplied button-type battery.

- 1 While pressing the Lock Button , pull out the Battery Holder. Then, remove the button-type battery.

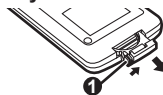

- 2 Insert the button-type battery with the (+) marking facing upward.



- 3 Insert the Battery Holder into the Remote Control.



- When the button-type battery is exhausted, replace it with a new CR2025 battery. (A battery is normally expected to last about 1 year. However, it depends on operation frequency.)
- Make sure to match the poles correctly when inserting the button-type battery.

## ⚠ WARNING

- Replace Battery with Panasonic or Lixing type CR2025 only. Use of another battery may present a risk of fire or explosion.
- Battery may explode if mistreated.
- As with any small object, this type of Battery can be swallowed by young children. Do not allow children to handle this Battery.

## ⚠ CAUTION

- Dispose of used battery promptly.
- Do not recharge, disassemble or dispose of in fire.

### ■ Using the Remote Control (PV-GS15 Only)

- 1 Direct the Remote Control at the Remote Control Sensor **31** of the Camcorder and press an appropriate button.

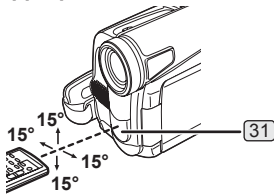

- Distance from the Camcorder: Within approximately 15 feet (5 meters)
- Angle: Within approximately 15° in the vertical and horizontal directions from the central axis
- The above operating ranges are for indoor use. Outdoors or under strong light, the Camcorder may not operate properly even within the above ranges.

### Selecting Remote Control Modes

When 2 Camcorders are used simultaneously, they can be operated individually by selecting different Remote Control Modes.

- If the Remote Control Mode of the Camcorder and that of the Remote Control do not match, [CHECK REMOTE MODE (REMOTE)] Indication is displayed.

### Setup on the Camcorder:

Set [REMOTE] on the [INITIAL] Sub-Menu to the desired Remote Control Mode. (p. 21)

### Setup on the Remote Control:

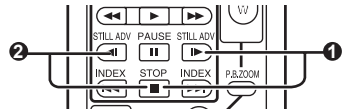

[VCR1]:

Press the [▶] Button and [■] Button simultaneously. ①

[VCR2]:

Press the [◀] Button and [■] Button simultaneously. ②

- When the battery in the Remote Control is replaced, the mode is automatically reset to [VCR1] Mode.

## Power Supply

### ■ Using the AC Adaptor

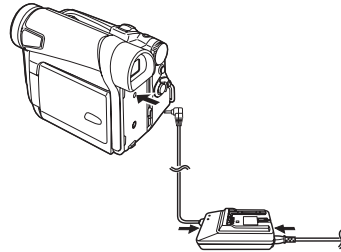

- 1 Connect the DC Cable to the Camcorder.
- 2 Connect the DC Cable to the AC Adaptor.
- 3 Connect the AC Cable to the AC Adaptor and the AC Jack.

- Before connecting or disconnecting the power supply, set the [OFF/ON] Switch **44** on the Camcorder to [OFF] and make sure that [POWER] Lamp is not lit. (p. 18)

### ■ Using the Battery

Before use, fully charge the Battery.

- We recommend using a Panasonic Battery.
- We cannot guarantee the quality of this Camcorder when batteries from other companies are used.

- 1 Attach the Battery to the AC Adaptor and charge it.

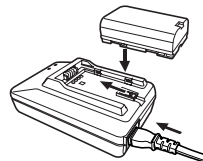

- Since the Battery will not be charged when the DC Cable is connected to the AC Adaptor, disconnect it from the AC Adaptor.
- The [POWER] Lamp and [CHARGE] Lamp light up, and charging starts.
- When the [CHARGE] Lamp goes off, charging is completed.
- When the battery is completely discharged, the [CHARGE] Lamp blinks at first, but the battery is charged normally. When the temperature of the battery is too high or low, the [CHARGE] Lamp blinks and the charging time becomes longer than usual.

## 2 Attach the charged Battery to the Camcorder.

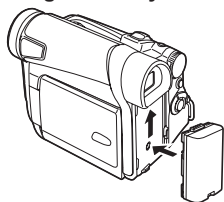

### Disconnecting the Power Source

Set the [OFF/ON] Switch (44) to [OFF], and while sliding the [BATTERY RELEASE] Switch (48), remove the Battery downward or DC Cable.

- When attaching or removing Battery, set the [OFF/ON] Switch to [OFF] and make sure the [POWER] Lamp is not lit.

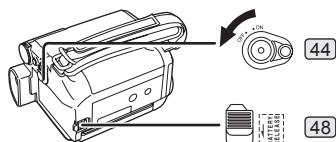

- For other notes concerning this item, see page 61.

## Charging Time and Available Recording Time

CGR-D08R	(A)	1 h
	(B)	2 h 10 min. (1 h 45 min.)
CGR-D14	(A)	1 h 30 min.
	(B)	3 h (2 h 25 min.)

(A) Charging Time

(B) Maximum Continuous Recording Time

- "1 h 30 min." indicates 1 hour and 30 minutes.
- Battery CGR-D08R (PV-GS9/PV-GS12/PV-GS14) or CGR-D14 (PV-GS15) is supplied.
- The times shown in the table are approximate times. The numbers indicate the recording time when the Viewfinder is used. The numbers in parentheses indicate the recording time when the LCD Monitor is used. In actual use, the available recording time may be shorter.

- The times shown in the table are for continuous recording at a temperature of 68 °F (25 °C) and humidity of 60 %. If the Battery is charged at a higher or lower temperature, the charging time may be longer.
- The available recording time becomes shorter if you use both of Viewfinder and LCD Monitor simultaneously when rotating the LCD Monitor forward to record yourself or setting [EVF ON/AUTO] to [ON].

## How to remove the Sensor tag

### 1 Detach the end of the Grip Belt.



### 2 Remove the Sensor tag. Then, replace the Grip Belt.

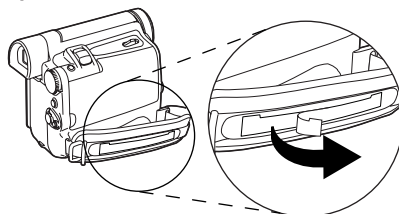

## The Grip Belt

### ■ To Use as a Grip Belt

Adjust the length of the Grip Belt to the size of your hand.

### 1 Detach the end of the Grip Belt.



### 2 Adjust the length of the Grip Belt to the size of your hand.

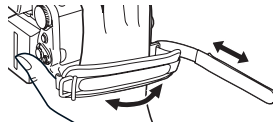

### 3 Reattach the Grip Belt.

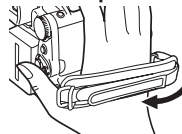



## Re-attaching the Lens Cap

To protect the Lens surface, attach the Lens Cap.

- The Lens Cap and Lens Cap Cord come preattached to the Grip Belt.



- 1 Pass one end of the Lens Cap Cord through the attached eye on the Lens Cap. Then pass the Lens Cap through the loop made by itself and pull tight.

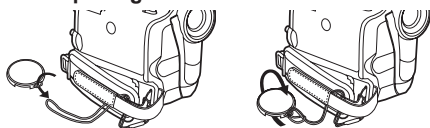

- When not using the Lens Cap, pull the Lens Cap Cord in the direction of the arrow. ①
- When you are not recording, be sure to cover the Lens with the Lens Cap for protection. ②

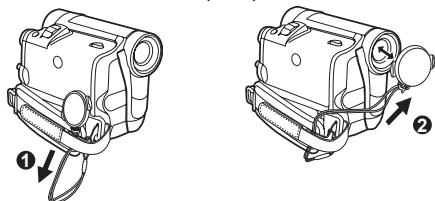

- When you remove the Lens Cap, press the knobs firmly.



## Attaching the Shoulder Strap

We recommend that you attach the Shoulder Strap before going out to avoid dropping the Camcorder.

- 1 Pull the end of the Shoulder Strap through the Shoulder Strap Holder on the Camcorder.

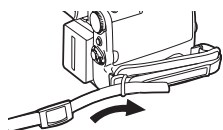

- 2 Fold the end of the Shoulder Strap, run it through the Shoulder Strap Length Adjuster, and pull it.

- Pull it out more than 1 inch (2 cm) ① from the Shoulder Strap Length Adjuster so that it cannot slip off.

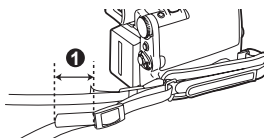

- Attach the other end of the Shoulder Strap to the other Shoulder Strap Holder in the same way.

## Inserting a Cassette

- 1 Slide the [OPEN/EJECT] Lever ③⑦ toward the front and pull down to fully open the Cassette Compartment Cover.

- To protect the tape, if the cover is not fully opened, the cassette cannot be ejected.



- 2 Insert a Cassette.

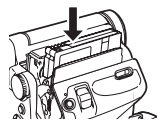

- 3 Close the Cassette Holder by pressing the [PUSH] mark ①.

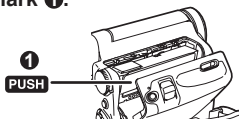

- 4 Close the Cassette Compartment Cover by pressing the mark ②.

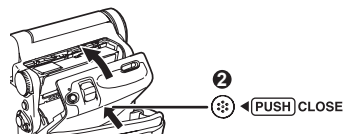

## Accidental Erasure Prevention

Opening the accidental erasure prevention slider ① on the cassette (by sliding it to the [SAVE] arrow direction) prevents recording. To enable recording, close the accidental erasure prevention slider (by sliding it to the [REC] arrow direction).



- For other notes concerning this item, see page 61.

## Using a Memory Card (For PV-GS12/ PV-GS14/PV-GS15)

A Card can be used to record still pictures.

- Use a genuine SD Memory Card or MultiMediaCard manufactured by Panasonic only.

**Before inserting or removing a Card, be sure to turn off the Camcorder.**

- Otherwise, the Camcorder may not function properly or it may cause the loss of recorded data in a Card.

### ■ Inserting a Card

- 1 Slide the [OPEN] Lever **3** to open the Card Slot Cover **5**.

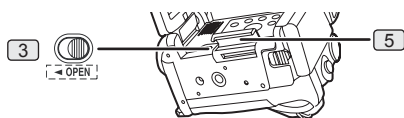

- 2 While holding the Memory Card with its cut corner facing right **1**, insert it into the Card Slot **4**.



- 3 Close the Card Slot Cover **5** securely.

### Removing the Card

Open the Card Slot Cover and press the center of the Card and then pull it straight out.

- After removing the Card, close the Card Slot Cover.
- The Camcorder may be damaged if the Card is forced out when the Card is fully inserted.

### ■ Card Access Lamp **12**

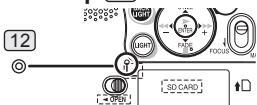

While the Camcorder is accessing the Card (reading, recording, playback or erasing), the Card Access Lamp lights up.

- While the Card Access Lamp is on, **never** attempt to open the Card Slot Cover, to pull out the Card, to turn off the Camcorder, or to turn the Mode Dial. Such actions will damage the Card, and recorded data, and cause the Camcorder to malfunction.

## Turning on the Camcorder

Turn on the power first and then select modes.

### ■ How to Turn on the Power

- 1 Set the [OFF/ON] Switch **44** to [ON] while pressing the button **1**.
  - The [POWER] Lamp **41** lights up.

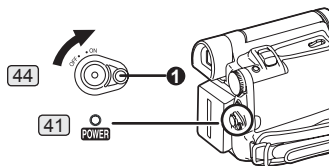

### ■ How to Turn off the Power

- 2 Set the [OFF/ON] Switch **44** to [OFF] while pressing the button **1**.



## Easy to Use Mode Dial

You can choose a desired mode by rotating the Mode Dial.

- 1 Rotate the Mode Dial **40**.

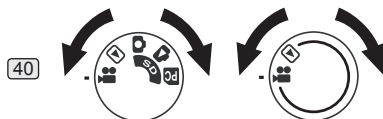

(PV-GS12/PV-GS14/  
PV-GS15)

(PV-GS9)



### Tape Recording Mode

Use this mode when recording pictures on a tape. Also, you can record still pictures on the card simultaneously while recording on a tape (For PV-GS12/PV-GS14/PV-GS15).



### Tape Playback Mode

Use this mode when playing back the recorded scene on a tape.



### Card Recording Mode (For PV-GS12/PV-GS14/PV-GS15)

Use this mode when recording still pictures on a card.



### Picture Playback Mode (For PV-GS12/PV-GS14/PV-GS15)

Use this mode when playing back the recorded still picture on a card.



### PC Mode (For PV-GS12/PV-GS14/PV-GS15)

Use this mode when you want to connect the Camcorder to your Personal Computer.

## Using the Viewfinder/LCD Monitor

### Using the Viewfinder

Before using the Viewfinder, adjust the field of view so that the displays inside the Viewfinder become clear and easy to read.

#### 1 Pull the Viewfinder.

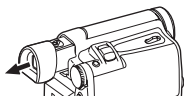

#### 2 Adjust by turning the Eyepiece Corrector Knob (35).

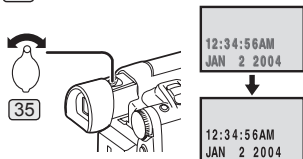

### To Use the Viewfinder at the Same Time as the LCD Monitor

Set [LCD/EVF] >> [EVF ON/AUTO] >> [ON].

- The Viewfinder does not turn off even if the LCD Monitor is opened.
- When you turn the Camcorder off, this setting is canceled.

### Using the LCD Monitor

With the LCD Monitor open, you can also record the picture while watching it.

#### 1 Place your Thumb on the [OPEN ▼] Knob (1) and pull the LCD Monitor (2) out in the direction of the arrow.

- The Viewfinder is now deactivated.
- The LCD Monitor can be opened a maximum of 120°. If you open the LCD Monitor by 120°, it becomes convenient to operate menus or to play back pictures.

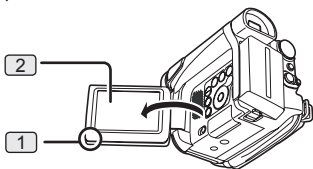

#### 2 Adjust the LCD Monitor angle according to the desired recording angle.

- The LCD Monitor can rotate a maximum of 180° (1) from the vertical position upwards and a maximum of 90° (2) to the downward direction. Forcefully rotating the LCD Monitor beyond these ranges will damage the Camcorder.

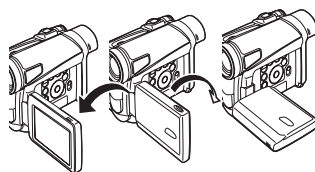

1 180° 2 90°

### Closing the LCD Monitor

Push the LCD Monitor until it is securely locked.

- Make sure the Card Slot Cover is closed.

### Adjusting Brightness and Color Level

When [LCD/EVF SET] on the [LCD/EVF] Sub-Menu is set to [YES], the following items are displayed.

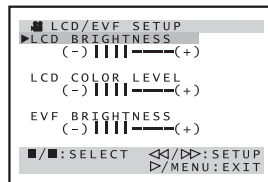

#### LCD Brightness [LCD BRIGHTNESS]

Adjusts the brightness of the image on the LCD screen.

#### LCD Color Level [LCD COLOR LEVEL]

Adjusts the color saturation of the image on the LCD screen.

#### Brightness of the Viewfinder

#### [EVF BRIGHTNESS]

Adjusts the brightness of the image in the Viewfinder.

#### To Adjust

Press the [II / ■] Button and select the item to be adjusted, and then press the [◀ / ▶] Button to raise or lower the number of vertical bars in the Bar Indication.

- More vertical bars indicates stronger brightness or color saturation.

- For other notes concerning this item, see page 68.

## Using the Menu Screen

To facilitate the selection of a desired function or setup, this Camcorder displays various function setups on Menus.

- When operating the menu with the Viewfinder, set [LCD/EVF] >> [EVF ON/AUTO] >> [ON] or rotate the LCD Monitor by 180°.

#### 1 Press the [MENU] Button (19).

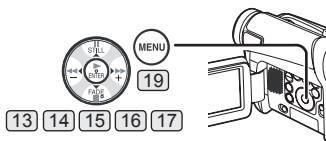

- The Menu corresponding to the Mode selected by using the Mode Dial (40) is displayed.

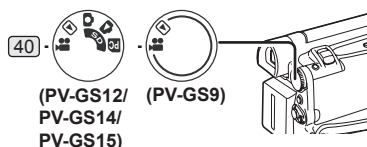

**2 Press the [II/■] Button (13) (16) to select a desired Sub-Menu.**

- Press the [II/■] Button to display the highlighted item.

**3 Press the [▶▶] Button (14) to display the selected Sub-Menu.**

**4 Press the [II/■] Button to select the item.**

**5 Press the [▶▶] Button (14) to display the selected item.**

**6 Press the [II/■] to select the desired mode and press the [ENTER] (15) Button to determine the setting.**

- While a Menu is displayed, you cannot record or play back. Menu can be displayed during playback but not during recording. The above operations can be done using the [MENU] Button, [▲▼◀▶] Buttons and [ENTER] Button on the Remote Control. (p. 14)

**To Return to the Previous Screen**

Press the [◀◀] Button (17).

**To Exit the Menu Screen**

Press the [MENU] Button again.

**About the Menu Mode Setting**

The setting selected on the Menu will be retained even when the Camcorder is turned off. However, if the Battery or AC Adaptor is disconnected before turning off the Camcorder, the selected setup may not be retained.

- Menu operation flow is shown in this text by >>.

**■ File Selection in the Picture Playback Mode (For PV-GS12/PV-GS14/PV-GS15)**

A File Selection Operation may be necessary during Menu Operations. In this case, carry out the following procedure.

**1 Press the [II/■/◀◀/▶▶] Button and select a file.**

- The selected file is marked by a frame.



**2 Press the [ENTER] Button (15) to confirm the selection of the file.**

- After the above File Selection Procedure, carry out the various Menu Operations. (The above procedure will not be repeated in the following instructions.)

**List of Menus**

The figures of the Menus are for explanation purposes only, and they are different from the actual Menus.

**■ [TAPE RECORDING MENU]**

Tape Recording Menu

(PV-GS12/PV-GS14/PV-GS15)

(PV-GS9)

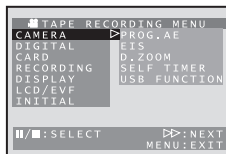

**1) [CAMERA]**

Camera Setup Sub-Menu

**[PROG.AE]**

Auto Exposure Mode (p. 30)

**[EIS]**

Image Stabilizer (p. 28)

**[D.ZOOM]**

Digital Zoom (p. 27)

**[SHTR EFFECT] (PV-GS9 Only)**

Shutter effect (p. 25)

**[SELF TIMER]**

Self-timer Recording (p. 27)

**[USB FUNCTION]**

USB Functions Mode (pp. 51, 54)

- If you press the [◀◀] Button, the menu changes back to the previous screen.

**2) [DIGITAL]**

Digital Setup Sub-Menu

**[EFFECT1]**

Digital Effects 1 (p. 33)

**[EFFECT2]**

Digital Effects 2 (p. 33)

**[MULTI MODE]**

Multi-Picture Mode (p. 33)

**[TITLE IN] (For PV-GS12/PV-GS14/PV-GS15)**

Adding a Title (p. 40)

**3) [CARD] (For PV-GS12/PV-GS14/PV-GS15)**

Card Setup Sub-Menu

**[PICT QUALITY]**

Picture Quality (p. 25)

**[CREATE TITLE]**

Title Creation (p. 40)

**4) [RECORDING]**

Recording Setup Sub-Menu

**[REC SPEED]**

Recording Speed Mode (p. 23)

**[AUDIO REC]**

Audio Recording Mode (p. 23)

**[SCENE INDEX]**

Scene Index Mode (p. 37)

**[WIND CUT]**

Wind Noise Reduction (p. 29)

**[ZOOM MIC]**

Zoom Microphone (p. 27)

**[CINEMA]**

Cinema-like Format Recording (p. 29)

**5) [DISPLAY]**

Display Setup Sub-Menu

**[DISPLAY]**

Display Mode (p. 60)

**[DATE/TIME]**

Date and Time Indication (p. 60)

**[C.DISPLAY]**

Counter Display Mode (p. 60)

**[C.RESET]**

Counter Reset (p. 71)

- It resets the counter to zero. However, it cannot reset the Time Code.

**6) [LCD/EVF]**

LCD/EVF Setup Sub-Menu

**[LCD/EVF SET]**

LCD and Viewfinder Adjustment (p. 19)

**[SELF REC]**

Recording Yourself (p. 26)

**[EVF ON/AUTO]**

Using the Viewfinder (p. 19)

**7) [INITIAL]**

Initial Setup Sub-Menu

**[BLANK SEARCH]**

Blank Search (p. 24)

**[DEMO MODE]**

Demonstration Mode

- If no operation takes place for approximately 10 minutes after the AC Adaptor is connected to the Camcorder and the [OFF/ON] Switch is turned to [ON] without inserting a Cassette or a Card, the Camcorder is automatically set to Demonstration Mode for introducing its functions. If any button is pressed or operated, the Demonstration Mode is canceled. The Demonstration Mode can be started by setting [DEMO MODE] to [ON] and by exiting the Menu. To terminate the Demonstration Mode, insert a Cassette or set the [DEMO MODE] to [OFF].

**[AV JACK]**

AV Jack (pp. 13, 65)

**[REMOTE]**

Remote Control Mode (p. 15)

**[BEEP SOUND]**

Beep Sound (p. 61)

**[CLOCK SET]**

Date and Time Setting (p. 23)

**[INITIAL SET]**

Initial Setting Mode (p. 60)

**■ [TAPE PLAYBACK MENU]**

Tape Playback Menu

(PV-GS12/PV-GS14/PV-GS15)

(PV-GS9)

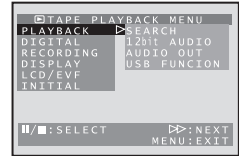
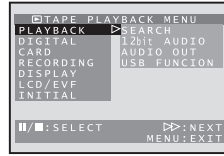

**1) [PLAYBACK]**

Playback Functions Sub-Menu

**[SEARCH]**

Index Search Mode (p. 37)

**[12bit AUDIO]**

Audio Selector (p. 44)

**[AUDIO OUT]**

Audio Output Mode (p. 64)

**[USB FUNCTION]**

USB Functions Mode (pp. 51, 54)

**2) [DIGITAL]**

Playback Digital Setup Sub-Menu

**[EFFECT ON]**

Digital Effect On/Off (p. 38)

**[EFFECT SEL]**

Digital Effect Selection (p. 38)

**[TITLE IN] (For PV-GS12/PV-GS14/PV-GS15)**

Adding a Title (p. 40)

**3) [CARD] (For PV-GS12/PV-GS14/PV-GS15)**

Card Setup Sub-Menu

**[PICT QUALITY]**

Picture Quality (p. 25)

**[CREATE TITLE]**

Title Creation (p. 40)

**4) [RECORDING]**

Recording Setup Sub-Menu

**[REC SPEED]**

Recording Speed Mode (p. 23)

**[AUDIO REC]**

Audio Recording Mode (p. 23)

**5) [DISPLAY]**

Display Setup Sub-Menu

**[DISPLAY]**

Display Mode (p. 60)

**[DATE/TIME]**

Date and Time Indication (p. 60)

**[C.DISPLAY]**

Counter Display Mode (p. 60)

**[C.RESET]**

Counter Reset (p. 71)

**6) [LCD/EVF]**

LCD/EVF Setup Sub-Menu

**[LCD/EVF SET]**

LCD and Viewfinder Adjustment (p. 19)

**[EVF ON/AUTO]**

Using the Viewfinder (p. 19)

**7) [INITIAL]**

Initial Setup Sub-Menu

**[BLANK SEARCH]**

Blank Search (p. 24)

**[AV JACK]**

AV Jack (pp. 13, 65)

**[REMOTE]**

Remote Control Mode (p. 15)

**[BEEP SOUND]**

Beep Sound (p. 61)

**■ [CARD RECORDING MENU]**

(For PV-GS12/PV-GS14/PV-GS15)

Card Recording Menu

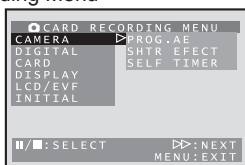

**1) [CAMERA]**

Camera Setup Sub-Menu

**[PROG.AE]**

Auto Exposure Mode (p. 30)

**[SHTR EFFECT]**

Shutter Effect (p. 25)

**[SELF TIMER]**

Self-timer Recording (p. 27)

**2) [DIGITAL]**

Digital Setup Sub-Menu

**[TITLE IN]**

Adding a Title (p. 40)

**3) [CARD]**

Card Setup Sub-Menu

**[PICT QUALITY]**

Picture Quality (p. 25)

**[CREATE TITLE]**

Title Creation (p. 40)

**[BURST MODE]**

RapidFire Consecutive Photoshot (p. 26)

**4) [DISPLAY]**

Display Setup Sub-Menu

**[DISPLAY]**

Display Mode (p. 60)

**[DATE/TIME]**

Date and Time Indication (p. 60)

**5) [LCD/EVF]**

LCD/EVF Setup Sub-Menu

**[LCD/EVF SET]**

LCD and Viewfinder Adjustment (p. 19)

**[SELF REC]**

Recording Yourself (p. 26)

**[EVF ON/AUTO]**

Using the Viewfinder (p. 19)

**6) [INITIAL]**

Initial Setup Sub-Menu

**[AV JACK]**

AV Jack (pp. 13, 65)

**[REMOTE]**

Remote Control Mode (p. 15)

**[BEEP SOUND]**

Beep Sound (p. 61)

**[CLOCK SET]**

Date and Time Setting (p. 23)

**[INITIAL SET]**

Initial Setting Mode (p. 60)

**■ [PICTURE PLAYBACK MENU]**

(For PV-GS12/PV-GS14/PV-GS15)

Picture Playback Menu

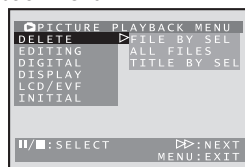

**1) [DELETE]**

Deleting a File Sub-Menu

**[FILE BY SEL]**

Selecting and Deleting a File (p. 42)

**[ALL FILES]**

Deleting All Files (p. 42)

**[TITLE BY SEL]**

Selecting and Deleting a Title (p. 42)

**2) [EDITING]**

Editing a File Sub-Menu

**[FILE LOCK]**

Setting the Lock (p. 41)

**[DPOF SET]**

Setting DPOF (p. 41)

**[CARD FORMAT]**

Formatting a Card (p. 42)

**3) [DIGITAL]**

Playback Digital Setup Sub-Menu

**[TITLE IN]**

Adding a Title (p. 40)

**4) [DISPLAY]**

Display Setup Sub-Menu

**[DISPLAY]**

Display Mode (p. 60)

**[DATE/TIME]**

Date and Time Indication (p. 60)

**[C.DISPLAY]**

Counter Display Mode (p. 60)

**[C.RESET]**

Counter Reset (p. 71)

**5) [LCD/EVF]**

LCD/EVF Setup Sub-Menu

**[LCD/EVF SET]**

LCD and Viewfinder Adjustment (p. 19)

**[EVF ON/AUTO]**

Using the Viewfinder (p. 19)

**6) [INITIAL]**

Initial Setup Sub-Menu

**[AV JACK]**

AV Jack (pp. 13, 65)

**[REMOTE]**

Remote Control Mode (p. 15)

**Setting Date and Time**

Since the internal clock of the Camcorder has a slight imprecision make sure to check the time before recording.

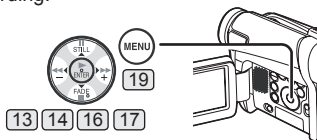

1 Set [INITIAL] >> [CLOCK SET] >> [YES].

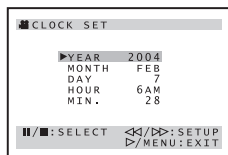

2 Press the [II/III] Button [13] [16] to select [YEAR], [MONTH], [DAY], [HOUR] or [MIN.] and press the [LEFT/RIGHT] [14] [17] to set it to the desired value.

- Year will cycle in the order shown below.  
2000, 2001, ..., 2089, 2000, ...

3 Press the [MENU] Button [19] to finish setting the date and time.

- The clock operation starts from [00] second.
- If the built-in battery is weak, the [BATT] Indication flashes. In this case, charge the built-in battery.
- The clock uses the 12-hour system.

**Internal Lithium Battery Recharge**

The internal lithium battery sustains the operation of the clock. When the [BATT] Indication flashes, the internal lithium battery is near exhaustion.



1 Connect the AC Adaptor to the Camcorder with the power turned off and then connect to the AC jack.

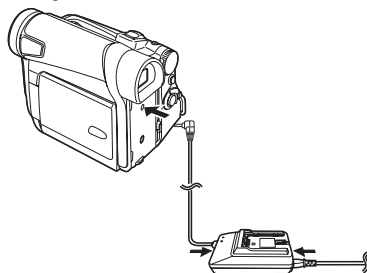

- After charging for 4 hours, the built-in lithium battery can power the clock for approximately 3 months.

**LP Mode**

A desired recording speed can be selected with [REC SPEED] on the [RECORDING] Sub-Menu.

**If LP Mode is selected, the recording time becomes 1.5 times longer than that of SP Mode.**

Although the image quality does not decrease with the LP Mode recording, mosaic-pattern noise may appear on a playback image, or some normal functions may be restricted.

- The contents that are recorded in LP Mode are not completely compatible with other equipment.
- Audio dubbing is not possible with LP Mode. (p. 44)

**Audio Recording Mode**

The sound quality of the recorded sound can be selected with [AUDIO REC] on the [RECORDING] Sub-Menu.

High sound-quality recording is possible with "16 bit 48 kHz 2 track" Mode. With the "12 bit 32 kHz 4 track" Mode, the original sound can be recorded on 2 tracks in stereo, while the other 2 tracks can be used for Audio Dubbing.

## Recording Mode

### About Recording

When recording pictures on a tape, set the Mode Dial (40) to Tape Recording Mode [RECORD].

When recording still pictures on a card, set the Mode Dial (40) to Card Recording Mode [PHOTO] (For PV-GS12/PV-GS14/PV-GS15).

When recording with the [AUTO/MANUAL/FOCUS] Switch (18) set to [AUTO], the Camcorder automatically adjusts the focus and white balance. In some cases, they cannot be adjusted automatically and need to be adjusted manually. (pp. 31, 32)

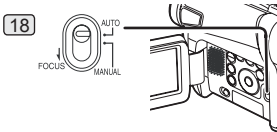

- Before turning on the power, remove the Lens Cap. If the Lens Cap is still attached when the power is turned on, Automatic White Balance Adjustment (p. 30) may not function correctly.
- When the Recording Pause Mode continues for more than 5 minutes, the power is turned off automatically for tape protection and power conservation. (If the AC Adaptor is used, the power is turned off only when the tape is inserted in Tape Recording Mode.) When the tape is inserted in Tape Recording Mode and if the Recording Pause Mode continues for more than 5 minutes the power is turned off automatically. To resume recording from this condition, turn off, then turn on the power again.
- When the Camcorder is connected to a personal computer with a USB Cable, Standby mode is not available.

### Recording on a Tape

#### 1 Set the [OFF/ON] Switch (44) to [ON].

- The [POWER] Lamp (41) lights up.

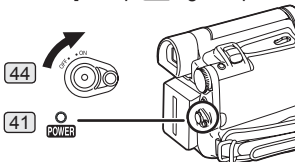

#### 2 Set the Mode Dial (40) to Tape Recording Mode.

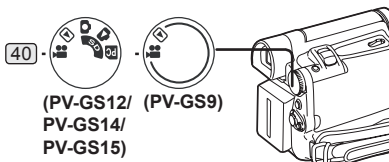

#### 3 Press the Recording Start/Stop Button (43).

- Recording starts.
- After [RECORD] is displayed, it changes to [REC].

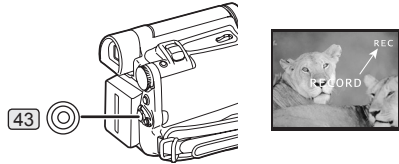

#### 4 Press the Recording Start/Stop Button (43) again to pause the recording.

- The [PAUSE] Indication is displayed.



### ■ Recording “Simultaneous Motion/Still Record Mode” (For PV-GS12/PV-GS14/PV-GS15)

Even if the Mode Dial is set to Tape Recording Mode and the recording to a tape is in progress, you can also record a still picture on a card by pressing the [PHOTO SHOT] Button.

### ■ To Check the Recording

By pressing the [CHECK] Button (7) briefly in the Recording Pause Mode, you can play back the last few seconds of the recorded scene.

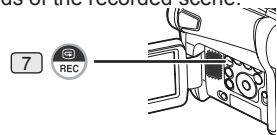

- The [CHK] Indication is displayed. After checking, the Camcorder resumes the Recording Pause Mode.
- For other notes concerning this item, see page 61.

### ■ Finding the End of Recording (Blank Search Function)

The Blank Search Function aids you in locating the end of the recording on the Cassette quickly.

#### 1 Set [TAPE RECORDING MENU] or [TAPE PLAYBACK MENU] >> [INITIAL] >> [BLANK SEARCH] >> [YES].

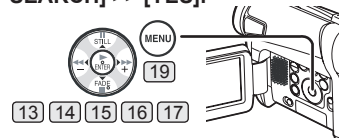

- The [BLANK] Indication appears during the Blank Search.
- Approximately 1 second before the last recorded scene, the Camcorder switches to the Recording Pause Mode or the Still Playback Mode.
- If there is no blank left on the Cassette, the Camcorder stops at the end of the tape.



**To Cancel Blank Search Before Completion**

Press the [■] Button.

**Digital Still Picture**

When the [STILL] Button [13] is pressed, images become still pictures. When the button is pressed again, the Digital Still Picture Mode is canceled.

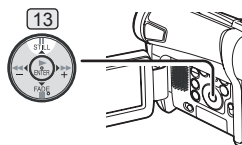

- We recommend that you press the [STILL] Button first at the position where you wish to record the still picture so as to enter the Digital Still Picture Mode and then press the [PHOTO SHOT] Button.

**Progressive Photoshot**

When the [P] Indication is displayed, Progressive Photoshot Function works. You can record still pictures with higher quality by using this function.

- The Progressive Photoshot Function may not be activated depending on the function you use. (p. 60)
- To record still pictures with higher quality, we recommend setting to the Card Recording Mode. (To activate the Progressive Photoshot Function regardless of the function you use)
- When you record onto the tape and the card simultaneously, the Progressive Photoshot Function is not activated.

**Recording a Still Picture on a Tape (PV-GS9 Only)**

Still pictures can be recorded from the Camcorder lens.

- 1 Press the [PHOTO SHOT] Button [36] in the Recording Pause Mode.

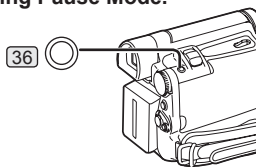
**Continuous Photoshot**

If you set [SHTR EFFECT] on the [CAMERA] Sub-Menu to [ON] and keep the [PHOTO SHOT] Button pressed, the Camcorder will continuously record still pictures in approximately 0.7 seconds intervals until the button is released.

- The screen blinks and, at the same time, a shutter clicking sound is recorded.

**Recording a Still Picture on a Card (Photoshot) (For PV-GS12/PV-GS14/PV-GS15)**

Still pictures can be recorded on the Memory Card from the Camcorder.

- 1 Set the Mode Dial [40] to Card Recording Mode.

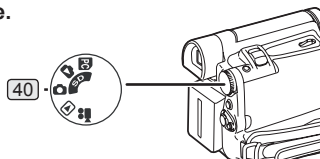

- 2 Press the [PHOTO SHOT] Button [36].

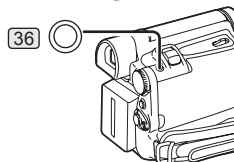

- The [PICTURE] Indication lights up in red.

**Selecting the quality of Photoshot images**

- 1 Set [CARD RECORDING MENU] >> [CARD] >> [PICT QUALITY] >> a desired image quality.

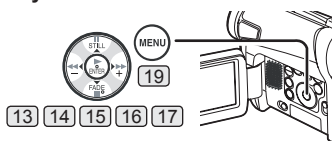
**Maximum number of images recordable on the supplied (PV-GS15 Only) Card (8MB)**

[FINE] (high image quality):

approximately 45 pictures

[NORMAL] (normal image quality):

approximately 95 pictures

[ECONOMY] (low image quality):

approximately 190 pictures

- These figures vary depending on the subject being photographed.

**Maximum number of still pictures recordable on an SD Memory card (optional)**

PICTURE QUALITY	FINE	NORMAL	ECONOMY
16 MB	100	200	400
32 MB	220	440	880
64 MB	440	880	1 760
128 MB	880	1 760	3 520
256 MB	1 760	3 520	7 040
512 MB	3 520	7 040	14 080

- These figures vary depending on the subject being photographed.

## ■ RapidFire Consecutive Photoshot

The still pictures can be recorded on a Card at regular intervals.

- 1 Set [CARD RECORDING MENU] >> [CARD] >> [BURST MODE] >> [ON].

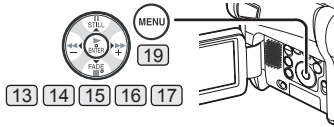

- The [ ] Indication appears.



- 2 Press the [PHOTO SHOT] Button [36].

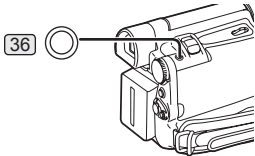

- When [ON] is selected, the still pictures can be recorded in approximately 0.5 second intervals until the [PHOTO SHOT] Button is released or 10 pictures are recorded.
- For other notes concerning this item, see pages 61-62.

## Recording Yourself

By opening the LCD Monitor and rotating it forward (to the lens side), you can let the subject in front of the Camcorder monitor the shot while recording is in progress.

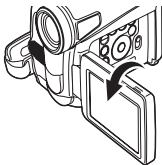

- When the LCD Monitor is opened, the Viewfinder is disabled automatically. However, when the LCD Monitor is rotated forward, the image is also shown in the Viewfinder.
- If you prefer to have the image on the LCD Monitor to look like an image in a mirror, set [SELF REC] on the [LCD/EVF] Sub-Menu to [MIRROR]. Images are recorded normally and no left and right reversal occurs.

## Recording with the Built-in LED Video Light (For PV-GS12/PV-GS14/PV-GS15)

To brighten the natural colors in a scene. Gain Up mode works with the Built-in Video Light to enhance the light's brightness.

- 1 Press the [LIGHT] Button [11]. ①

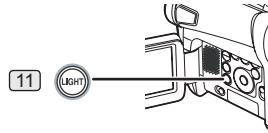

- The Built-in LED Video Light lights and the Gain Up mode is set to on.
- Gain Up mode will be brighter than when only the Video Light is on, however, ghost images will appear.

- 2 Press the [LIGHT] Button. ②

- Gain Up mode is set to off.
- To eliminate ghost images, use this mode.

- 3 Press the [LIGHT] Button. ③

- The Video Light turns off.
- Pressing the [LIGHT] Button again returns to ①.

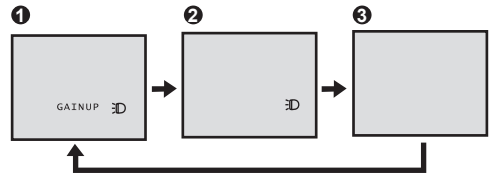

- For other notes concerning this item, see page 62.

## Quick Start

By pressing the [QUICK START] Button [42], the Camcorder will be ready for recording in approximately 1.3 seconds after it is turned on.

- 1 Press the [QUICK START] Button [42].

- The Quick Start Recording Lamp [42] lights up.

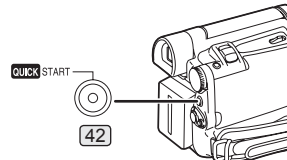

- 2 Set the [OFF/ON] Switch [44] to [OFF].

- The Quick Start Recording Lamp remains lit.



### 3 Set the [OFF/ON] Switch (44) to [ON].

- The Camcorder will be ready for recording in approximately 1.3 seconds.

#### To Cancel the Quick Start

Keep the [QUICK START] Button pressed for approximately 2 seconds and make sure the Quick Start Recording Lamp is not lit.

- For other notes concerning this item, see page 62.

## Self-timer Recording

When you set the self-timer, the recording starts automatically after 10 seconds on the Tape (PV-GS9 Only) or the Card (For PV-GS12/PV-GS14/PV-GS15).

- Set [TAPE RECORDING MENU] (PV-GS9 Only) or [CARD RECORDING MENU] (For PV-GS12/PV-GS14/PV-GS15) >> [CAMERA] >> [SELF TIMER] >> [ON].

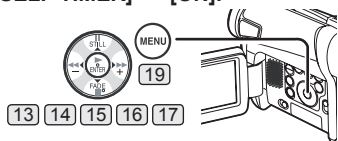

- The [ ] Indication appears.

- Press the [PHOTO SHOT] Button (36).

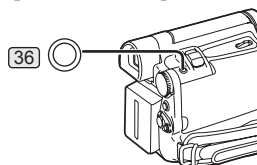

- The [ ] Indication flashes and the recording starts after 10 seconds.
- You can also use the RapidFire Consecutive Photoshot (For PV-GS12/PV-GS14/PV-GS15). (p. 26)
- For other notes concerning this item, see page 62.

## Zoom In/Out Functions

This feature gives special effects to the picture by recording objects close by or with wide-angle shot.

- For wide-angle shots (zoom out):  
Push the [W/T] Lever (26) towards [W].  
For close-ups (zoom in):  
Push the [W/T] Lever towards [T].

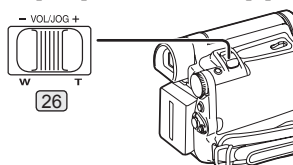

- Zoom Magnification Indication is displayed for a few seconds.



### To Take Close-up Shots of Small Subjects

#### (Macro Close-up Function)

When the zoom magnification is 1X, the Camcorder can focus on a subject that is as close as approximately 0.8 inches (20 mm) from the Lens. Small subjects like insects can be recorded with this function.

### To Use the Zoom Microphone Function

Along with the zooming operation, the microphone's directional angle and sensitivity are varied for recording sounds.

- Set [TAPE RECORDING MENU] >> [RECORDING] >> [ZOOM MIC] >> [ON]. (The [Z.MIC] Indication is displayed.)

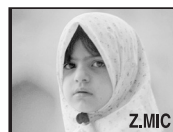

- For other notes concerning this item, see page 62.

## Digital Zoom Function

This function is useful when you want to record close-up shots of subjects located beyond a normal zoom range of 1X to 20X (PV-GS9/PV-GS12)/22X (PV-GS14)/24X (PV-GS15) magnification. With the Digital Zoom Function, you can select a magnification from 50X up to 800X.

- Set [TAPE RECORDING MENU] >> [CAMERA] >> [D.ZOOM] >> [50X] or [800X].

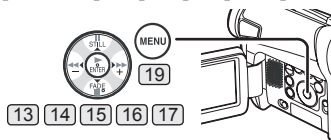

- 50X : Digital zooming to 50X
- 800X : Digital zooming to 800X

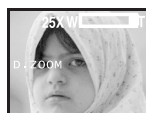

- 2 Push the [W/T] Lever **26** towards [W] or towards [T] to zoom in or out.

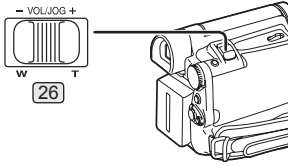

### To Cancel the Digital Zoom Function

Set [TAPE RECORDING MENU] >> [CAMERA] >> [D.ZOOM] >> [OFF].

- For other notes concerning this item, see page 62.

### Image Stabilizer Function

If the Camcorder is shaken while recording, the camera shake in the image can be corrected.

- If the Camcorder shakes too much, the images may not be stabilized.

- 1 Set [TAPE RECORDING MENU] >> [CAMERA] >> [EIS] >> [ON].

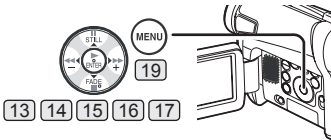

- The [EIS] Indication appears.



- 2 Press the Recording Start/Stop Button **43** or [PHOTO SHOT] Button **36** to start recording.

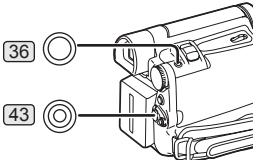

### To Cancel Image Stabilizer Function

Set [TAPE RECORDING MENU] >> [CAMERA] >> [EIS] >> [OFF].

- For other notes concerning this item, see page 62.

## Fade In/Out Functions

### Fade In

Fade In brings out images and sounds gradually from a black screen at the beginning of a scene.



- 1 Keep pressing the [FADE] Button **16** during the Recording Pause Mode.

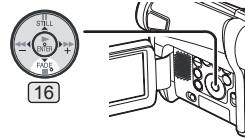

- The image fades out gradually.

- 2 When the image is completely gone, press the Recording Start/Stop Button **43** to start recording.

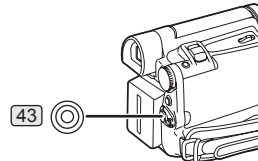

- 3 Release the [FADE] Button **16** about 3 seconds after recording starts.

- The image reappears gradually.

### Fade Out

Fade Out causes images and sounds to disappear gradually, leaving a black screen at the end of a scene.

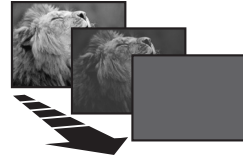

- 1 Keep pressing the [FADE] Button **16** while recording.

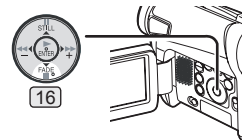

- The image fades out gradually.

- 2 When the image is completely gone, press the Recording Start/Stop Button **[43]** to stop recording.

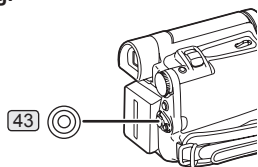

- 3 Release the [FADE] Button **[16]**.

- The still picture cannot fade in or fade out.

### Backlight Compensation Function

This prevents the subject from being recorded too darkly when backlit. (Backlight is the light that shines from behind the subject being recorded.)

- 1 Press the [BACK LIGHT] Button **[10]**.

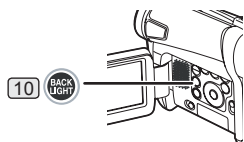

- The [ ] Indication flashes and then is displayed.
- The entire screen becomes brighter.



#### To Resume Normal Recording

Press the [BACK LIGHT] Button.

- For other notes concerning this item, see page 62.

### MagicPix Function

This function allows you to record color images brightly in a dark place without using the Video Flash.

- 1 Press the [MAGICPIX] Button **[8]**.

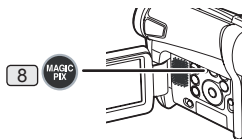

- The [MAGICPIX] Indication appears.



#### To Cancel the MagicPix Function

Press the [MAGICPIX] Button again.

- For other notes concerning this item, see pages 62-63.

### Soft-Skin Mode

This enables you to record skin colors in a softer tone. In order to get the best result, avoid background colors similar to the skin color of the subject. Otherwise, this may result in a softer background lacking in detail.

- 1 Press the [SOFT SKIN] Button **[9]**.

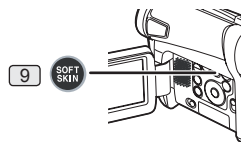

- The [SOFT SKIN] Indication appears.



- To obtain the best effect, we recommend to take a bust shot, so that the upper part from the breast of the subject can be framed in the screen.

#### To Cancel the Soft-Skin Mode

Press the [SOFT SKIN] Button.

### Wind Noise Reduction Function

This function reduces the sound of wind hitting the microphone when recording.

- 1 Set [TAPE RECORDING MENU] >> [RECORDING] >> [WIND CUT] >> [ON].

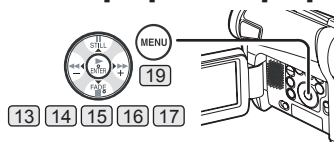

- The [WIND CUT] Indication appears.



#### To Cancel the Wind Noise Reduction Function

Set [TAPE RECORDING MENU] >> [RECORDING] >> [WIND CUT] >> [OFF].

- For other notes concerning this item, see page 63.

### Cinema Function

This function is for recording a cinema-like image.

- 1 Set [TAPE RECORDING MENU] >> [RECORDING] >> [CINEMA] >> [ON].

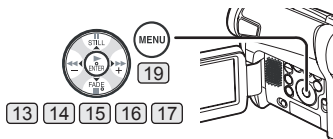

- Black bars appear at the top and bottom of the screen.



**To Cancel the Cinema Function**

Set [TAPE RECORDING MENU] >> [RECORDING] >> [CINEMA] >> [OFF].

- For other notes concerning this item, see page 63.

**Recording in Special Situations**

**(Program AE)**

You can select optimal automatic exposure under specific recording situations.

- 1 Set the [AUTO/MANUAL/FOCUS] Switch (18) to [MANUAL].

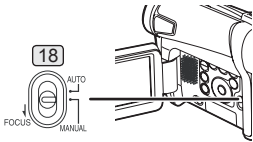

- The [MNL] Indication appears.

- 2 Set [TAPE RECORDING MENU] or [CARD RECORDING MENU] (For PV-GS12/PV-GS14/PV-GS15) >> [CAMERA] >> [PROG.AE] >> a desired mode ([Sports], [Portrait], [Low Light], [Spotlight] or [Surf & Snow]).

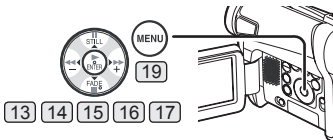

- The Indication of the selected Mode appears.

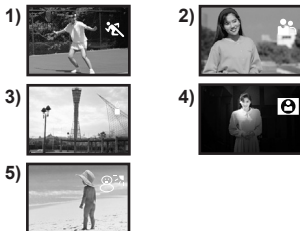

- 1) [Sports] Sports Mode

- For recording scenes involving quick movements, such as sports scenes.

- 2) [Portrait] Portrait Mode

- Use when you want to make people (subjects) stand out from the background.

- 3) [Low Light] Low Light Mode

- For brightening a dark scene.

- 4) [Spotlight] Spotlight Mode

- For recording a subject under a spotlight.

- 5) [Surf & Snow] Surf & Snow Mode

- For recording in glaring surroundings, such as ski slopes, beaches, etc.

**To Cancel the Program AE Function**

Set the [PROG.AE] on the [CAMERA] Sub-menu to [OFF]. Or, set the [AUTO/MANUAL/FOCUS] Switch to [AUTO].

- For other notes concerning this item, see page 63.

**Recording in Natural Colors**

**(White Balance)**

Depending on the scene or lighting conditions, the Automatic White Balance Adjustment Mode may not be able to bring out natural colors. In this case, the white balance can be adjusted manually.

When the Camcorder is turned on with the Lens Cap on, the Automatic White Balance Adjustment may not function properly. Please turn on the Camcorder after removing the Lens Cap.

- 1 Set the [AUTO/MANUAL/FOCUS] Switch (18) to [MANUAL].

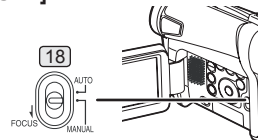

- The [MNL] Indication appears.

- 2 Press the [ENTER] Button (15).

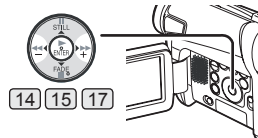

- The [AWB] Indication appears.

- 3 Press the [Right Arrow] Button (14) or [Left Arrow] Button (17) to select a desired White Balance Mode.

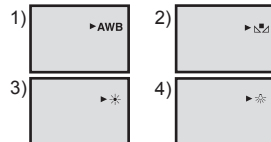

- 1) Automatic White Balance Adjustment [AWB]
- 2) The white balance setting that was previously set manually [MNL]
- 3) Outdoor Mode [ \* ]
- 4) Indoor Mode (recording under incandescent lamp) [ ☼ ]

### To Resume Automatic Adjustment

Press the [▶▶] Button [14] or [◀◀] Button [17] until the [AWB] Indication appears. Or, set the [AUTO/MANUAL/FOCUS] Switch to [AUTO].

### Adjusting White Balance Manually

White Balance Adjustment recognizes the color of light and adjusts so that white will appear pure white. The Camcorder determines the hue of light that comes through the Lens and White Balance Sensor, thereby judging the recording condition, and selects the closest hue setting. This function is called Automatic White Balance Adjustment.

For light outside the functional Auto White Balance Adjustment range, use the Manual White Balance Adjustment Mode.

- 1 Set the [AUTO/MANUAL/FOCUS] Switch [18] to [MANUAL].

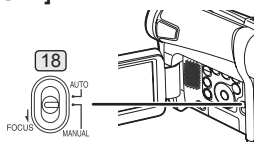

- The [MNL] Indication appears.

- 2 Press the [ENTER] Button [15].

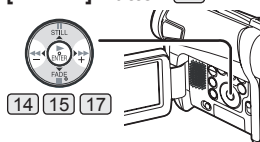

- The [AWB] Indication appears.

- 3 Press the [▶▶] Button [14] or [◀◀] Button [17] until the [☼] Indication is displayed.



- 4 Point the Camcorder at a full-screen white subject.

- 5 Keep pressing [ENTER] Button [15] until the [☼] Indication stops flashing.

### To Resume Automatic Adjustment

Press the [▶▶] Button [14] or [◀◀] Button [17] until the [AWB] Indication is displayed. Or, set the [AUTO/MANUAL/FOCUS] Switch to [AUTO].

### About White Balance Sensor

The White Balance Sensor [31] determines the nature of the light source during recording.

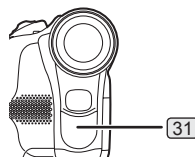

- Do not cover the White Balance Sensor with your hand during recording because White Balance will not function normally.

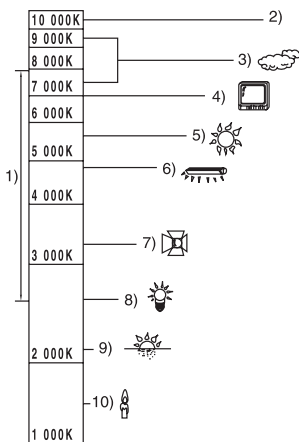

Outside of the effective range of Automatic White Balance Adjustment, the image will become reddish or bluish. Even within the effective range of Automatic White Balance Adjustment, the Automatic White Balance Adjustment may not function properly if there is more than one light source. In this case, adjust the White Balance.

- 1) The effective range of Automatic White Balance Adjustment on this Camcorder
- 2) Blue sky
- 3) Cloudy sky (rain)
- 4) TV screen
- 5) Sunlight
- 6) White fluorescent lamp
- 7) Halogen light bulb
- 8) Incandescent light bulb
- 9) Sunrise or sunset
- 10) Candlelight

- For other notes concerning this item, see page 63.

## Manual Shutter Speed Adjustment

Useful for recording fast-moving subjects.

- 1 Set the [AUTO/MANUAL/FOCUS] Switch (18) to [MANUAL].

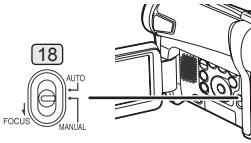

- The [MNL] Indication appears.

- 2 Press the [ENTER] Button (15) until the Shutter Speed Indication appears.

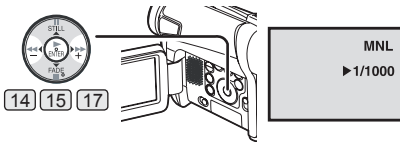

- 3 Press the [▶▶] Button (14) or [◀◀] Button (17) to adjust the shutter speed.

### Range of Shutter Speed Adjustment

1/60–1/8000 s in Tape Recording Mode

1/60–1/500 s in Card Recording Mode

(For PV-GS12/PV-GS14/PV-GS15)

The standard shutter speed is 1/60 s.

Selecting a speed closer to [1/8000] causes the shutter speed to be faster.

### To Resume Automatic Adjustment

Set the [AUTO/MANUAL/FOCUS] Switch to [AUTO].

- For other notes concerning this item, see page 63.

## Manual Iris Adjustment

### (F Number)

You can use this function when the screen is too bright or too dark.

- 1 Set the [AUTO/MANUAL/FOCUS] Switch (18) to [MANUAL].

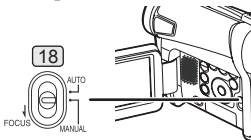

- The [MNL] Indication appears.

- 2 Press the [ENTER] Button (15) until the Iris Indication appears.

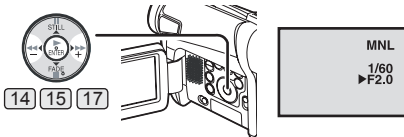

- 3 Press the [▶▶] Button (14) or [◀◀] Button (17) to adjust the iris.

### Range of Iris Adjustment

CLOSE (Closed), F16, ..., F2.0,

OP (Opened) + 0dB, ..., OP + 18dB

When a value closer to [CLOSE] is selected, the image becomes darker.

When a value closer to [OP + 18dB] is selected, the image becomes brighter.

The value to which + dB is attached indicates a Gain-up value. If this value is too large, the quality of the image deteriorates.

### To Resume Automatic Adjustment

Set the [AUTO/MANUAL/FOCUS] Switch to [AUTO].

- For other notes concerning this item, see page 63.

## Manual Focus Adjustment

Focus can be adjusted manually for recording in a situation where auto focus may not function well.

- 1 Set the [AUTO/MANUAL/FOCUS] Switch (18) to [MANUAL].

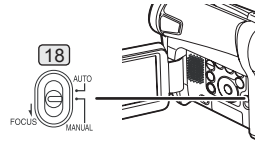

- The [MNL] Indication appears.

- 2 Slide the [AUTO/MANUAL/FOCUS] Switch (18) to [FOCUS].

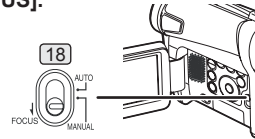

- The [▶MF] Indication (Manual Focus Mode) appears.

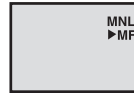

- 3 Press the [▶▶] Button (14) or [◀◀] Button (17) to adjust the focus.

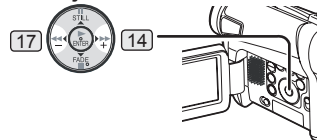

- If you keep pressing the [▶▶] Button (14) or [◀◀] Button, the speed of adjusting becomes faster.

### To Resume Automatic Adjustment

Set the [AUTO/MANUAL/FOCUS] Switch to [AUTO] or [FOCUS].



## Digital Effect Functions

This Camcorder is equipped with Digital Effect Functions that add special effects to the scene.

### Digital Effects 1 [EFFECT1]

1) MULTI



2) P-IN-P



3) WIPE



4) MIX



5) STROBE



6) TRAIL



7) MOSAIC



8) MIRROR



9) STRETCH



10) SLIM



- 1) Multi Mode [MULTI]
- 2) Picture-In-Picture Mode [P-IN-P]
- 3) Wipe Mode [WIPE]
- 4) Mix Mode [MIX]
- 5) Strobe Mode [STROBE]
  - Records images with a stroboscopic effect.
- 6) Trailing Effect Mode [TRAIL]
  - Records images with a trailing effect.
- 7) Mosaic Mode [MOSAIC]
  - Produces a mosaic-like image.
- 8) Mirror Mode [MIRROR]
  - The right half of an image becomes a mirror image of the left half.
- 9) Stretch Mode [STRETCH]
  - The picture is expanded horizontally.
- 10) Slim Mode [SLIM]
  - The picture is expanded vertically.

### Digital Effects 2 [EFFECT2]

11) NEGA



12) SEPIA



13) B/W



14) SOLARI



- 11) Negative Mode [NEGA]
  - The colors of the recorded image are inverted as seen in a negative.
- 12) Sepia Mode [SEPIA]
  - It records a scene with a brownish tint, like the color of old pictures.
- 13) Black & White Mode [B/W]
  - It records an image in black and white.
- 14) Solarisation Mode [SOLARI]
  - It records an image with a painting-like effect.

### To Select a Desired Digital Effect

Set [TAPE RECORDING MENU] >> [DIGITAL] >> [EFFECT1] or [EFFECT2] >> a desired Digital Effect.

### To Cancel the Digital Effect

Set [TAPE RECORDING MENU] >> [DIGITAL] >> [EFFECT1] or [EFFECT2] >> [OFF].

- For other notes concerning this item, see pages 63-64.

## Multi-Picture Mode

### Strobe Multi-Picture Mode:

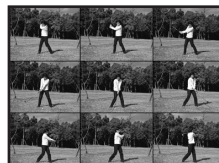

You can capture and record 9 consecutive small still pictures.

### Manual Multi-Picture Mode:



You can manually capture and record 9 small still pictures.

- 1 Set [TAPE RECORDING MENU] >> [DIGITAL] >> [EFFECT1] >> [MULTI].

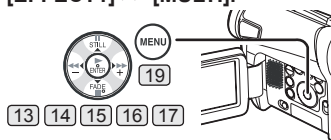

- 2 Set [TAPE RECORDING MENU] >> [DIGITAL] >> [MULTI MODE] >> [STROBE] or [MANUAL].

- 3 Press the [MULTI] Button (20).

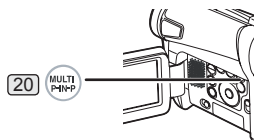

- If [MANUAL] is selected, press the [MULTI] Button at each scene you want to capture.

**Deleting All the Captured Multi-Pictures**

While 9 multi-pictures are displayed, press the [MULTI] Button.

- If [MANUAL] has been selected, press the [MULTI] Button after 9 pictures are displayed.

**To Display the Multi-Pictures Again**

Press the [MULTI] Button for 1 second or longer.

**To Delete Multi-Pictures One by One (When pictures were captured in [MANUAL])**

When the [MULTI] Button is pressed for 1 second or longer while the still pictures are displayed, the pictures captured last are deleted continuously.

- After still pictures are deleted one by one, they cannot be displayed again.

- For other notes concerning this item, see page 64.

**Picture-in-Picture Mode**

You can display a sub-screen (still picture) inside the screen.

- 1 Set [TAPE RECORDING MENU] >> [DIGITAL] >> [EFFECT1] >> [P-IN-P].

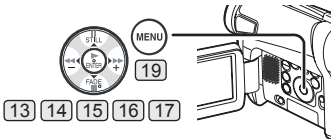

- 2 Aim the Camcorder at the scene you want to capture and press the [P-IN-P] Button (20) to insert a small still picture.

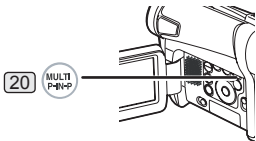

- A small still picture is displayed in a normal picture.
- If the [P-IN-P] Button is pressed again, the small still picture is cleared.

- For other notes concerning this item, see page 64.

**Wipe Mode and Mix Mode****Wipe Mode:**

Like drawing a curtain, the still picture of the last recorded scene gradually changes to the moving image of a new scene.

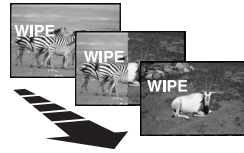
**Mix Mode:**

While the moving image of a new scene fades in, the still image of the last recorded scene gradually fades out.

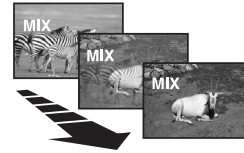

- 1 Set [TAPE RECORDING MENU] >> [DIGITAL] >> [EFFECT1] >> [WIPE] or [MIX].

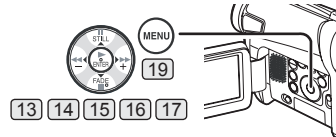

- The [WIPE] or [MIX] Indication appears.

- 2 Press the Recording Start/Stop Button (43) to start recording.

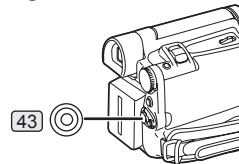

- 3 Press the Recording Start/Stop Button (43) to pause the recording.

- The last scene is stored in memory. The [WIPE] or [MIX] Indication changes to [WIPE] or [MIX].

- 4 Press the Recording Start/Stop Button (43) to restart the recording.

- The last image of the previous scene gradually changes to the new scene.

- For other notes concerning this item, see page 64.

## Playback Mode

### Playing Back a Tape

The recorded scene can be played back immediately after the recording.

**1 Set the [OFF/ON] Switch 44 to [ON].**

- The [POWER] Lamp 41 lights up.

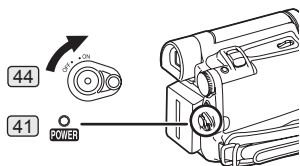

**2 Set the Mode Dial 40 to Tape Playback Mode.**

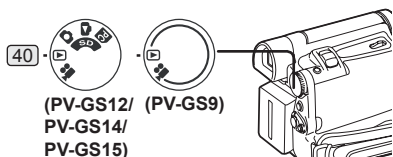

**3 Press the [◀◀] Button 17 to rewind the tape.**

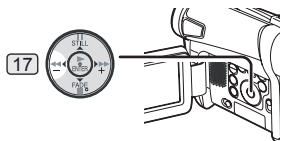

- Rewind the tape to the point where you want to start playback.
- When the tape reaches the beginning, rewinding stops automatically.

**4 Press the [▶▶] Button 15 to start playback.**

- The [▶] Indication appears.

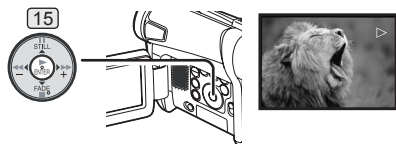

- If a cassette recorded with copyright protection signal is played back, the picture is distorted by mosaic-like patterns.

### To Stop Playback

Press the [■] Button 16.

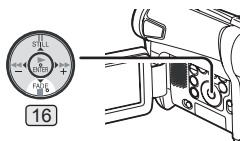

### ■ Adjusting the Sound Volume

To adjust the volume, push the [W/T] Lever 26 to display the [VOLUME] Indication. Push the [W/T] Lever towards [T] to increase the volume or push the [W/T] Lever towards [W] to decrease the volume. The [VOLUME] indication disappears immediately after adjustment is made.

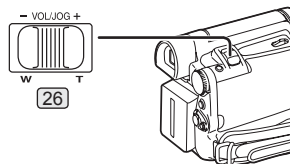

To adjust the volume with the Remote Control, press the [T] or [W] Button to display the [VOLUME] Indication. Press the [T] Button to increase the volume or press the [W] Button to decrease the volume. The [VOLUME] indication disappears immediately after adjustment is made.



- The sound volume cannot be adjusted using the Remote Control in Playback Zoom Mode. (pp. 37-38)
- For other notes concerning this item, see page 64.

### Finding a Scene You Want to Play Back

#### ■ Cue/Review Playback

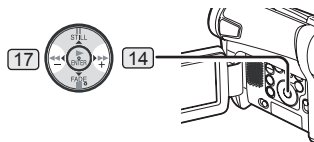

If the [▶▶] Button 14 or [◀◀] Button 17 is pressed during Playback, it turns to Cue Playback (A) or Review Playback (B).



- If the Button is held continuously, it turns to Cue Playback or Review Playback until you release it.

### ■ Variable Speed Search Function

The speed of Cue Playback or Review Playback can be varied.

#### 1 During playback, press the [▶] Button (15).

- The [1X▷] Indication appears.

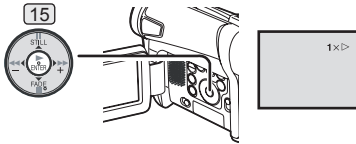

#### 2 Push the [W/T] Lever (26) to select a desired search speed.

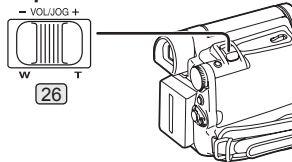

The following 6 playback speeds are available for the Variable Speed Search Function in both the fast-forwarding and rewinding directions:

- 1/5X (slow playback in SP Mode only), 1/3X (slow playback in LP Mode only), 1X, 2X, 5X, 10X and 20X.
- This function works by pressing the [VAR. SEARCH] and cursor buttons ([▲], [▼]) on the Remote Control. (p. 14)

#### To Resume Normal Playback

Press the [▶] Button (15).

- During Cue or Review Playback, fast-moving images may show mosaic-like patterns.
- The sound is muted during search.

### Slow Motion Playback (Remote Control Only)

- This feature is only available with Remote Control. However it is not supplied for models PV-GS9/PV-GS12/PV-GS14. If you would like to order, the parts number is LSSQ0411 as a replacement parts. Please refer to page 74.

This Camcorder can play back at a slow speed.

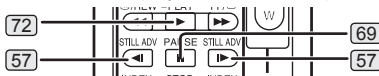

#### 1 Press the [▶] Button (72).

#### 2 Press the [◀] Button or [▶] Button (57) on the Remote Control.

- The [◀] or [▶] Indication appears.



- When the [◀] Button is pressed, Slow Motion Playback proceeds in the reverse direction. When the [▶] Button is pressed, Slow Motion Playback proceeds in the forward direction.

Scenes recorded in the SP Mode are played back at approximately 1/5th of the normal speed. Scenes recorded in the LP Mode are played back at approximately 1/3rd of the normal speed.

#### To Resume Normal Playback

Press the [▶] Button (72).

- If the Camcorder is left in the Slow Motion Playback Mode for more than 10 minutes, the Camcorder switches to the Stop Mode to protect the video heads from excessive wear and tear.

### Still Playback/Still Advance Playback

This Camcorder is capable of still picture playback and frame-advance playback.

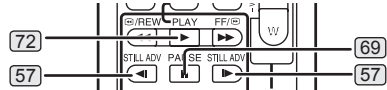

#### 1 Press the [▶] Button (72).

#### 2 Press the [II] Button (69).

- The playback image stops in the Still Playback Mode.

#### 3 Press the [◀] Button or [▶] Button (57) on the Remote Control.

- With each press of the [◀] Button, still pictures advance in the reverse direction. With each press of the [▶] Button, still pictures advances in the forward direction. If one of the buttons continues to be pressed, still pictures advance continuously 1 frame at a time until the button is released.

#### To Resume Normal Playback

Press the [▶] Button (72).

### ■ Playback with Zoom Lever

By pushing the [W/T] Lever (26) of the Camcorder in the Still Playback Mode, still pictures can be advanced one frame at a time in the forward or backward direction. If you keep pushing the Lever, still pictures advance continuously.

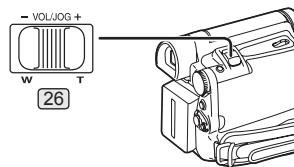

- If the Camcorder is left in the Still Playback Mode for more than 5 minutes, the Camcorder switches to the Stop Mode to protect the video heads from excessive wear and tear.

## Index Search Functions (Remote Control Only)

- This feature is only available with Remote Control. However it is not supplied for models PV-GS9/PV-GS12/PV-GS14. If you would like to order, the parts number is LSSQ0411 as a replacement parts. Please refer to page 74.

To facilitate searching for desired scenes, this Camcorder automatically records index signals during recording, as explained in the following.

### Photoshot Index Signal (PV-GS9)

These signals are automatically recorded whenever still pictures are taken in Photoshot Mode. (p. 25) Photoshot Index Signals are not recorded on still pictures recorded in Continuous Photoshot Mode. (PV-GS12/PV-GS14/PV-GS15)

These signals are automatically recorded when still pictures on a card are recorded to a tape.

### Scene Index Signal

Scene Index Signals are automatically recorded when you start recording after inserting a Cassette.

- If [SCENE INDEX] of [RECORDING] Sub-Menu on the [TAPE RECORDING MENU] is set to [2HOUR], an index signal is recorded when recording is restarted after an elapse of 2 hours or longer. If it is set to [DAY], an index signal is recorded when recording is restarted after the date has changed since the last recording. (While the index signal is being recorded, the [INDEX] Indication flashes for a few seconds.)



- If the Camcorder is switched from the Tape Playback Mode to Tape Recording Mode or if the date and time is set before the start of recording, the index signal is not recorded.

### Photoshot Index Search

- Set [TAPE PLAYBACK MENU] >> [PLAYBACK] >> [SEARCH] >> [PHOTO].

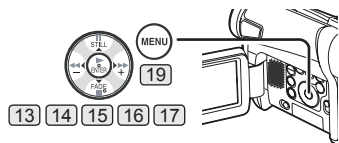

- Press the [▶▶] Button or [◀◀] Button [58] on the Remote Control.



- With each press of the corresponding button, still pictures recorded in Photoshot Mode are searched.

### Scene Index Search

- Set [TAPE PLAYBACK MODE] >> [PLAYBACK] >> [SEARCH] >> [SCENE].

- Press the [▶▶] Button or [◀◀] Button [58] on the Remote Control.

- When the corresponding button is pressed once, the [S 1] Indication appears, and searching for the subsequent scene marked with an index signal starts. Each time the button is pressed after the start of Scene Index Search, the indication changes, from [S 2] to [S 9], and the beginning of the scene corresponding to the selected number will be searched.



- Up to 9 scene numbers can be selected.

### Continuous Index Search

If the [▶▶] Button or the [◀◀] Button [58] is pressed for 2 seconds or longer, search can be continued at several-second intervals. (To cancel, press the [▶] Button [72] or the [■] Button [70].)

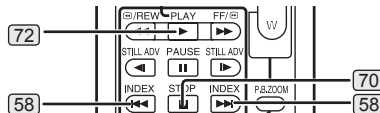

- For other notes concerning this item, see page 64.

### Playback Zoom Function (Remote Control Only)

- This feature is only available with Remote Control. However it is not supplied for models PV-GS9/PV-GS12/PV-GS14. If you would like to order, the parts number is LSSQ0411 as a replacement parts. Please refer to page 74.

A part of the image can be enlarged up to 10 times during playback.

- During playback, press the [P.B. ZOOM] Button [74] on the Remote Control.

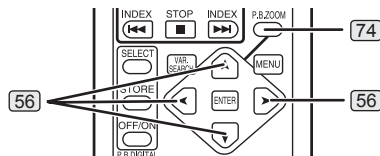

- The center of the image is enlarged by approximately 2 times.

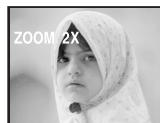

**To Change the Zoom Magnification**

2 Change the magnification by pressing the [W] Button or [T] Button [62] on the Remote Control.

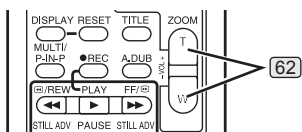

**To Change the Enlarging Area of an Image**

3 Press the Arrow Button (▲, ◀, ▶, ▼) [56] on the Remote Control that points to the area you want to enlarge.

**To Cancel the Playback Zoom Function**

Press the [P.B. ZOOM] Button [74] on the Remote Control.

- For other notes concerning this item, see page 64.

**Playback Digital Effect Functions**

During playback, special digital effects can be added to the recorded pictures. The same effects as those of Digital Effects 1 and 2, which are used during recording, are obtained.

1 Press the [▶] Button [72].



2 Press the [SELECT] Button [59] on the Remote Control to select a desired digital effect.

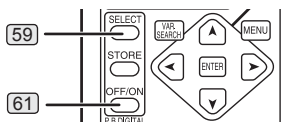

- When the [SELECT] Button is pressed repeatedly, the digital effect selection changes.
- The same setting can be done using [EFFECT SEL] Sub-Menu on the [TAPE PLAYBACK MENU].

**To suspend Playback Digital Effect Temporarily**

Press the [OFF/ON] Button [61] to suspend or restart the digital effect. When the digital effect is paused temporarily, the selected effect's indication flashes.

- The same operating can be done using [EFFECT ON] Sub-Menu on the [TAPE PLAYBACK MENU].

**To Cancel the Digital Effect**

Press the [SELECT] Button [59] repeatedly on the Remote Control and clear the digital effect indication.

**Wipe Mode and Mix Mode (Remote Control Only)**

- This feature is only available with Remote Control. However it is not supplied for models PV-GS9/ PV-GS12/PV-GS14. If you would like to order, the parts number is LSSQ0411 as a replacement parts. Please refer to page 74.

1 Press the [▶] Button [72].



2 Press the [SELECT] Button [59] on the Remote Control and select [WIPE] or [MIX].

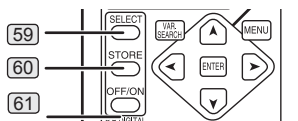

3 Press the [STORE] Button [60] at the moment you want to save as a still picture.

- The [WIPE] or [MIX] Indication appears, and the image is saved.

4 Press the [OFF/ON] Button [61] in the scene in which you want to use the Wipe or Mix effect.

- The scene changes as a result of the Wipe or Mix effect.
- The Wipe Function and Mix Function can only be accessed by using the Remote Control during playback.
- If the [OFF/ON] Button [61] is pressed while Wipe or Mix is carried out, the effect will stop temporarily at that point. Pressing the [OFF/ON] Button [61] again will bring back the effect.

- For other notes concerning this item, see page 64.

**Playing Back a Memory Card (For PV-GS12/ PV-GS14/PV-GS15)**

It plays back files recorded on a Card.

1 Set the Mode Dial [40] to Picture Playback Mode.

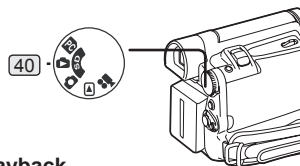

2 Start Playback.

- ▶ : Starting the Slide Show
- ▶▶ : Playing back the next picture
- ◀◀ : Playing back the previous picture
- : Stop the Slide Show
- || : Pause the Slide Show

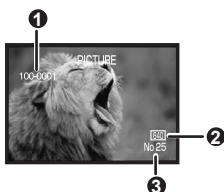

- ❶ Folder File Number
- ❷ Picture Size (p. 60)
- ❸ File Number

**To Select a Desired File and Playing Back**

**1 Set the Mode Dial (40) to Picture Playback Mode.**

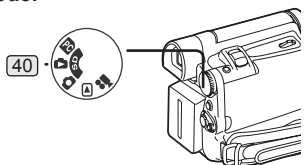

**2 Press the [MULTI] Button (20).**

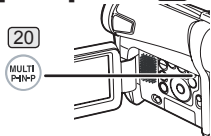

- The files recorded on the Card are displayed in Multi-Picture Mode.

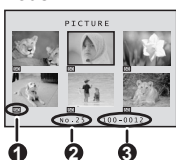

- ❶ Picture Size
- ❷ File Number
- ❸ Folder File Number

**3 Press the [II/■/◀/▶] Button (13) (14) (16) (17) to select a desired file.**

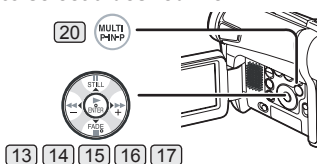

- The selected file is marked with a frame.

**4 Press either the [ENTER] Button (15) or the [MULTI] Button (20).**

- The selected file is shown on the entire screen.

- For other notes concerning this item, see page 64.

**Slide Show (For PV-GS12/PV-GS14/PV-GS15)**

The recorded still pictures in the Card can be played back like a Slide Show.

**1 Set the Mode Dial (40) to Picture Playback Mode.**

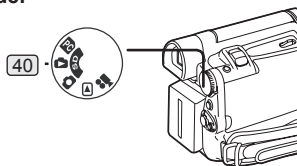

**2 Press the [▶] Button (15).**

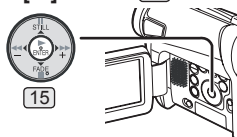

- The [SLIDE ▶] Indication is displayed.



- Each of the pictures are played back for several seconds.

**To Pause the Slide Show**

Press the [II] Button.

- The [SLIDE II] Indication is displayed.



**To Stop the Slide Show**

Press the [■] Button.

- For other notes concerning this item, see page 64.

## Creating a Title (For PV-GS12/ PV-GS14/PV-GS15)

You can create a title and record on a Card.

### 1 Recording Mode:

Set the Mode Dial (40) to Tape Recording Mode or Card Recording Mode. Set the Lens to the image you want to use for creating a title.

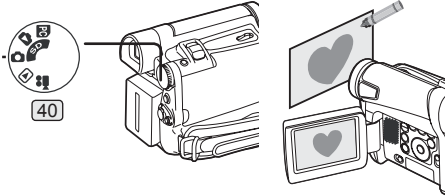

### 1 Tape Playback Mode:

Search for the image you want to use for creating a title and set the Camcorder to the Still Playback Mode.

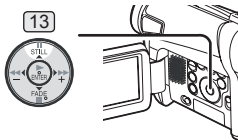

### 2 Set [CARD] >> [CREATE TITLE] >> [YES].

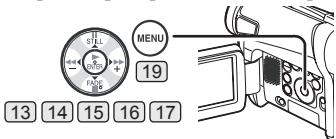

### 3 Press the [PHOTO SHOT] Button (36).

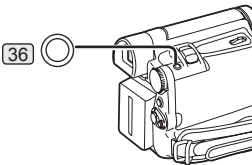

- The title is stored.
- To perform Photoshot again, select [RETURN].

### 4 Select [LUMINANCE] and press the [ENTER] Button (15), then press the [▶▶] Button (14) or [◀◀] Button (17) to adjust the title contrast and press the [ENTER] Button (15).

### 5 Press the [▶▶] Button (14) or [◀◀] Button (17) to adjust the color and press the [ENTER] Button (15).

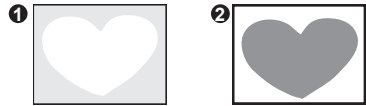

- The dark portion of the image is missing ①, and the colors of the bright portion change in order of black, blue, green, cyan, red, magenta, yellow and white, after which the bright portion of the image is missing ② and the colors of the dark portion change in the above order.

### 6 Select [RECORDING] and press the [ENTER] Button (15).

- The title is recorded on the Card.

- For other notes concerning this item, see page 65.

## Adding a Title (For PV-GS12/PV-GS14/ PV-GS15)

A title can be added to the picture. It is displayed in Tape/Card Recording Mode and Tape/Picture Playback Mode.

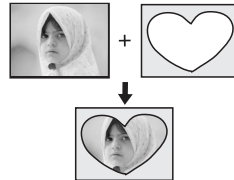

### 1 Set [DIGITAL] >> [TITLE IN] >> [ON].

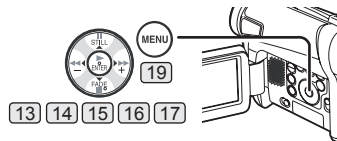

- The title is displayed.

### 2 Press the [MENU] Button (19).

### 3 Press the [MULTI] Button (20).

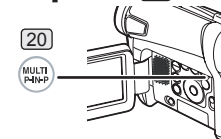

- A Multi Title Screen is displayed.

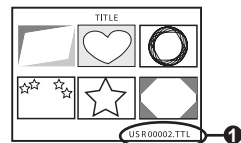

- File Name ①



- 4 Press the [II/III/◀/▶] Buttons (13, 14, 16, 17) to select a desired title.

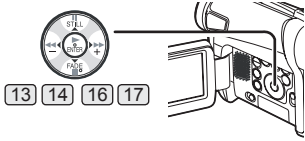

- The selected title is marked with a frame.

- 5 Press the [MULTI] Button (20).

- The selected title is displayed.
- Recording and Photoshot Recording can be made with pictures that have titles.

**To Clear the Title Display**

Set [DIGITAL] >> [TITLE IN] >> [OFF]. Or, press the [TITLE] Button (66) on the Remote Control.

- For other notes concerning this item, see page 65.

**Writing Printing Data on a Card (For PV-GS12/PV-GS14/PV-GS15)**

**(DPOF Setting)**

DPOF Setting Printing data (DPOF Settings), such as the number of images to be printed, can be written to the Card. "DPOF" means Digital Print Order Format.

- 1 Set the Mode Dial (40) to Picture Playback Mode.

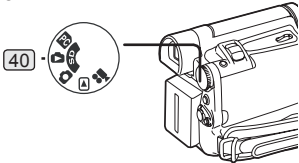

- 2 Set [PICTURE PLAYBACK MENU] >> [EDITING] >> [DPOF SET] >> [YES] >> [VARIABLE].

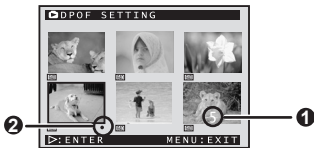
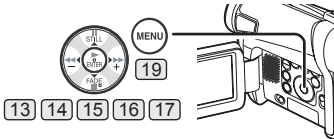

- When all images are not printed, select [ALL 0].

- 3 Select a desired picture and press the [ENTER] Button (15).

- The selected picture is marked with a frame.
- The number of prints set by DPOF (1) is displayed.

- 4 Press the [▶▶] Button (14) or [◀◀] Button (17) to select the number of pictures to be printed, and press the [ENTER] Button (15).

- [●] Indication (2) is displayed in the picture set. (p. 60)

- 5 Repeat Steps 3 and 4 and press the [MENU] Button (19) when the setup is completed.

**To Verify DPOF Setting**

Select [VERIFY] in Step 2. The pictures for which 1 or more print is set in DPOF are played back continuously.

- For other notes concerning this item, see page 65.

**Protecting the Files on a Card (For PV-GS12/PV-GS14/PV-GS15)**

**(Lock Setting)**

Precious files recorded on a Card can be locked to prevent accidental erasure. (Even if files are locked, the files will be deleted if the Card is formatted.)

- 1 Set [PICTURE PLAYBACK MENU] >> [EDITING] >> [FILE LOCK] >> [YES].

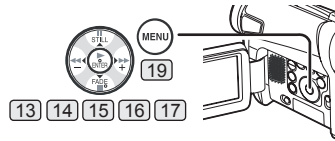

- 2 Select the file to be locked, and press the [ENTER] Button (15).

- The selected file is locked and the [O-TR] Indication (1) appears. Repeat this procedure to lock 2 or more files.
- Press the [ENTER] Button (15) again to cancel.
- The SD Memory Card has a write protection switch. (p. 65)

- For other notes concerning this item, see page 65.

## Deleting the Files Recorded on a Card (For PV-GS12/PV-GS14/PV-GS15)

Using the Camcorder, you can delete the files recorded on a Card. After the file is deleted, it cannot be restored.

### To Select and Delete Files or Titles

- 1 Set [PICTURE PLAYBACK MENU] >> [DELETE] >> [FILE BY SEL] >> [YES].

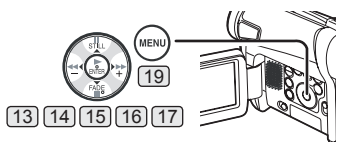

- To erase a title in [PICTURE PLAYBACK MENU], select [TITLE BY SEL].

- 2 Select the file you wish to delete and press the [ENTER] Button [15].

- The selected picture is marked with a frame.
- To erase 2 files or more, repeat this step.

- 3 Press the [PHOTO SHOT] Button [36].

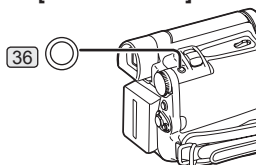

- A verification message appears.

- 4 Select [YES] and press the [ENTER] Button [15].

- The selected file is deleted from the Card.
- If [NO] is selected, the file selection is canceled.

### To Select and Delete All Files

- 1 Set [PICTURE PLAYBACK MENU] >> [DELETE] >> [ALL FILES] >> [YES].

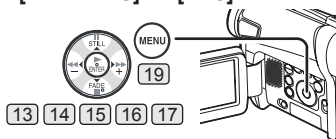

- A verification message appears.

- 2 Select [YES] and press the [ENTER] Button [15].

- All files of Picture Playback Mode are erased.
- A locked file cannot be erased.
- If there are many files on a card, it may take longer to delete files.

## Formatting a Card (For PV-GS12/ PV-GS14/PV-GS15)

If a Card becomes unreadable by the Camcorder, format it for reuse. Formatting erases all the data recorded on a Card.

- 1 Set [PICTURE PLAYBACK MENU] >> [EDITING] >> [CARD FORMAT] >> [YES].

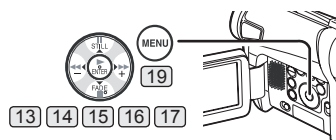

- A confirmation message appears, select [YES] and formatting will be carried out.

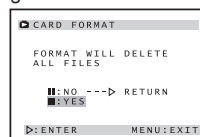

- When the formatting is completed, the screen becomes white.
- It may not be able to use the Card formatted by this Camcorder on another unit. In this case, format the Card on the unit which will use the Card. Make sure that valuable pictures are stored on your PC before proceeding.
- A Card formatted on other equipment (e.g. PC) might be unusable or it might take more time for recording. We recommend that you use this equipment to format the Card.

## Playing Back on Your TV

By connecting your Camcorder with your TV, the recorded scenes can be viewed on your TV screen.

- Before connecting them, turn off the power of both the Camcorder and TV.

### 1 Connect the [AV OUT] Jack of the Camcorder and the Video and Audio Input Jacks of the TV.

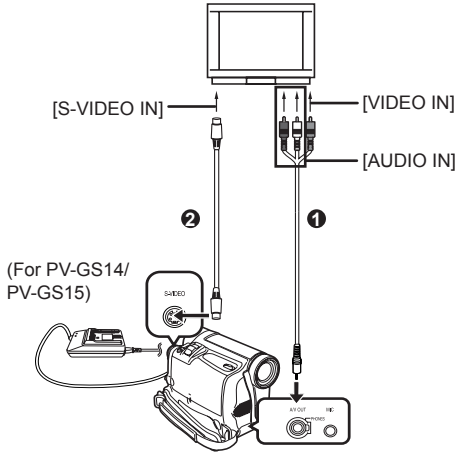

- Connect to the TV with the AV Cable ①. If the TV has an S-Video Jack, connect the S-Video Cable (not supplied) ②, too (For PV-GS14/PV-GS15).
- When plugging the pin plug of the AV cable into the [AV OUT] Jack, plug it in as far as it goes.

### To Make the Indications Appear on the TV Screen

Press the [OSD] Button [51] on the Remote Control.

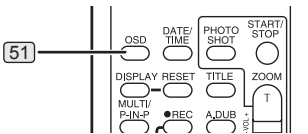

- For other notes concerning this item, see page 65.

## Editing Mode

### Recording from a Tape onto a Card (For PV-GS12/PV-GS14/PV-GS15)

Still pictures can be recorded on the Memory Card from scenes that have already been recorded on a cassette.

1 Set the Mode Dial (40) to Tape Playback Mode.

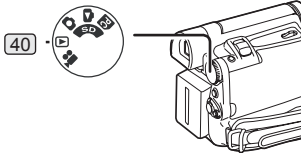

2 Start playback and set the Camcorder to Still Playback Mode at the scene you wish to record, and press the [PHOTO SHOT] Button (36).

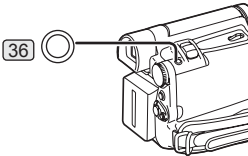

### Recording Pictures from a Card onto a Tape (For PV-GS12/PV-GS14/PV-GS15)

Card Images can be recorded to the Tape.

1 Set the Mode Dial (40) to Picture Playback Mode.

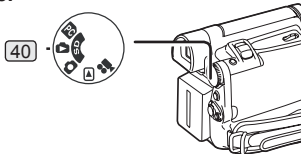

2 Display the first picture.

3 Press the [PHOTO SHOT] Button (36).

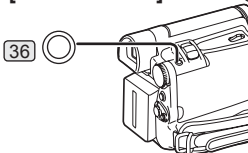

- During the copying, the following Indication appears.



- It takes a few seconds to record a picture to the Tape.

- When recording to tape, select the tape position before recording. The picture will be recorded to the tape position when the [PHOTO SHOT] Button is pressed at Step 3.
- Photoshot index signals are automatically recorded.
- For other notes concerning this item, see page 65.

### Audio Dubbing (Remote Control Only)

- This feature is only available with Remote Control. However it is not supplied for models PV-GS9/ PV-GS12/PV-GS14. If you would like to order, the parts number is LSSQ0410 as a replacement parts. Please refer to page 74.

You can add music or narration to the recorded Cassette.

- If the tape recorded in the [16bit] Mode is dubbed with the Audio Dubbing function, the original sound is erased. (If you wish to preserve the original sound, use the [12bit] Mode when recording.)
- Audio Dubbing cannot be performed on a recording made in LP Mode. (p. 23)

1 Press the [II] Button (69) on the Remote Control where you want to add new sound.

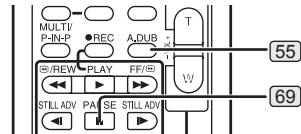

2 Press the [A.DUB] Button (55) on the Remote Control.

3 To start Audio Dubbing, press the [II] Button (69) on the Remote Control.

#### To Cancel Audio Dubbing

Press the [II] Button (69) on the Remote Control. The Camcorder is in the Still Playback Mode again.

#### To Play Back the Sound Recorded by 12bit Audio Dubbing

Set [TAPE PLAYBACK MENU] >> [PLAYBACK] >> [12bit AUDIO] >> [ST1], [ST2] or [MIX].

- ST1: It plays back only the original sound.
- ST2: It plays back only the sound added by Audio Dubbing.
- MIX: It plays back both the original sound and the sound added by Audio Dubbing simultaneously.

**To Dub Audio While Listening to a Pre-recorded Sound**

When pausing the audio dubbing, set the [12bit AUDIO] on the [PLAYBACK] Sub-Menu to [ST2] and you can check the pre-recorded sound. When a microphone (For PV-GS14/PV-GS15) is used for audio dubbing, use headphones to listen to the pre-recorded sound while dubbing the audio. (When using headphones, set [AV JACK] on the [INITIAL] to [OUT/PHONES].) When the line input is used, you can dub audio while listening to the pre-recorded sound from the speaker.

- For other notes concerning this item, see page 65.

**Copying on an S-VHS (or a VHS) Cassette**

**(Dubbing)**

After connecting the Camcorder and the VCR as illustrated, start the following procedures.

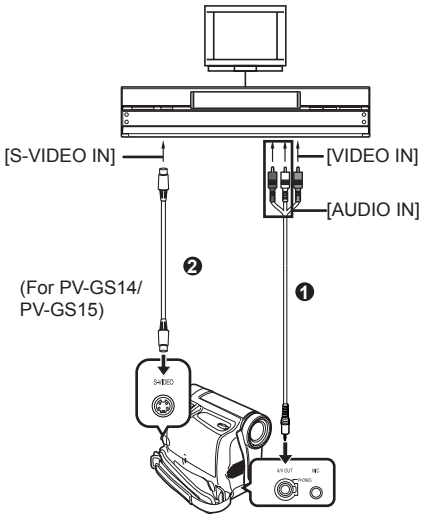

(For PV-GS14/  
PV-GS15)

- ① AV Cable
- ② S-Video Cable (not supplied)

- Be sure to press the [OSD] Button (p. 14) on the Remote Control prior to copying so that no indications are visible. Otherwise, the displayed tape counter and function indications are also copied.

- Camcorder:**  
1 Insert the recorded Cassette.

- VCR:**  
2 Insert an unrecorded Cassette with an erasure prevention tab.  
• If various setups (such as external input, tape speed, etc.) are required, please refer to the operating instructions of your VCR.

- Camcorder:**  
3 Press the [▶] Button to start playback.

- VCR:**  
4 Start recording.  
5 Press the Pause or Stop Button to stop recording.

- Camcorder:**  
6 Press the [■] Button to stop playback.

**Using the DV Cable for Recording**

**(Digital Dubbing)**

By connecting this Camcorder with other digital video equipment (such as another Camcorder of the same format/model) that has a DV input/output Terminal, and using a 4-pin to 4-pin DV Interface Cable PV-DDC9 (optional) ①, high quality images and sounds can be dubbed in the digital mode.

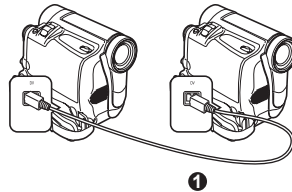

- Player/Recorder:**  
1 Insert the Cassette and set to Tape Playback Mode.

- Player:**  
2 Press the [▶] Button [72] to start playback.

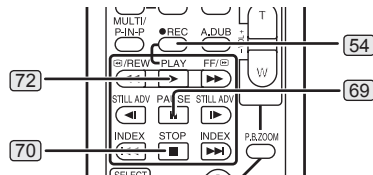

**Recorder:**

3 While pressing the [● REC] Button (54), press the [PLAY] Button (72) on the Remote Control. Or while pressing the [REC] Button (7), press the [BACK LIGHT] Button (10) on the Camcorder.

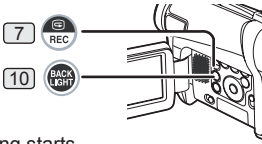

- Recording starts.

**To Stop Dubbing**

Press the [||] Button (69) or the [■] Button (70).

**CAUTION:**

Unauthorized exchanging and/or copying of copyrighted recordings may be copyright infringement.

- For other notes concerning this item, see page 65.

## PC Connection With DV Interface Cable

A video clip can be transferred directly to your PC (Personal Computer) via a DV Interface Cable (Optional) using products and software from a number of video editing software companies.

Using products from video editing software companies allows you to capture and edit video clips using the DV Interface.

Our DVC being OHCI compliant should have no problem working with any OHCI compliant Firewire Card/video - Editing software package.

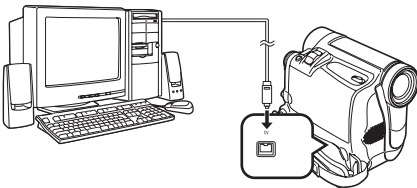

- Personal Computer must be equipped with an DV Terminal.
- During Camcorder playback, do not disconnect the DV Interface Cable or turn the Camcorder off as this may cause a PC hang-up error.
- 1394 (i.LINK) Interface must conform to OHCI (Open Host Controller Interface Specification).

## With a PC

### Using the Software with a Personal Computer

An image stored on the DV Cassette or Memory Card can be transferred to your personal computer.

#### ■ Software Installation (For Windows)

##### 1 Turn on the personal computer and start up Windows.

##### 2 Insert the CD-ROM into the personal computer's CD-ROM drive.

- The [Setup Menu] screen appears.



[PV-GS15: Supplied]



[PV-GS9/PV-GS12/PV-GS14:  
Optional Software]

##### 3 Select the software to be installed from [Setup Menu].

###### • USB Driver (pp. 47-49) :

Software for USB Driver allows you to transfer images directly from the Memory Card into the computer.

###### • WebCam Driver (pp. 50-53) :

If the Camcorder is connected to your personal computer, you can send video from the Camcorder to the other parties via the network.

###### • DV STUDIO 3.1E-SE (Optional Software) (pp. 53-55) :

With DV STUDIO 3.1E-SE software, your favorite scene on a tape can be captured to your personal computer as a still image. Also, images viewed through the camera lens can be captured to your personal computer.

###### • ArcSoft Software (pp. 55-56) :

PhotoImpression 4 and PhotoBase 4 are included.

###### • Acrobat Reader (Optional Software) :

To view the installed operating instructions, Adobe Acrobat Reader 5.0 or higher is required. Please install Adobe Acrobat Reader from the CD-ROM (Optional Software).

##### 4 Follow the instructions on the computer screen until the installation is complete.

- Setup window will disappear when the installation is complete.
- If a window does not appear automatically, click the "Start" Button on your desktop and then click "Run". When the "Run" Box is open, type in "D:\InstMenu.exe" and click "OK". ("D" applies when the CD-ROM drive is drive D.)

## Using USB Driver

### ■ Operating environment

- Despite having the Operating environment indicated, it may not be possible to use the program with some types of personal computers.
- A CD-ROM drive is required to install this program.

#### OS:

IBM PC/AT compatible personal computer with preinstalled;  
Microsoft Windows XP Home Edition/Professional  
Microsoft Windows 2000 Professional  
Microsoft Windows Me (Millennium Edition)  
Microsoft Windows 98 Second Edition

#### CPU:

Intel Pentium II/Celeron 300 MHz or higher  
(including compatible CPU)

#### RAM:

32 MB or more (64 MB or more recommended)  
(128 MB or more required for Windows XP)

#### Free hard disk space:

At least 30 MB or more

#### Ports:

USB Jack

### ■ Installing USB Driver

Please install USB Driver first before connecting the Camcorder to your personal computer with the USB Cable.

##### 1 Turn on the personal computer and start up Windows.

##### 2 Insert the CD-ROM into the personal computer's CD-ROM drive.

- Quit all applications.
- The [Setup Menu] Screen appears.



[PV-GS15: Supplied]



[PV-GS9/PV-GS12/PV-GS14:  
Optional Software]

##### 3 Click the [USB Driver].

- The set up program starts running.

##### 4 For Windows 98SE/Me/2000 users, click

- [Restart] if the [InstallShield] dialog appears.
- Do not remove the CD-ROM.



## 5 Finish installation by following the on-screen instructions.

- Click [Next] and proceed with installation.
- After completing the installation, Click [Finish].

## 6 After the USB Driver is installed, please restart your computer.

- Reboot the computer to finish installing USB driver.
- Installation continues after the computer reboots if you selected additional software.
- A message indicating a conflict between versions may be displayed during the installation. This will not cause a problem. Simply click [Yes] to proceed with the installation.
- Depending on the OS version, illustrations and icon names may vary.

### ■ Windows 98SE/Me Users

The following messages may be displayed when connecting this Camcorder and your personal computer via USB Cable.

#### 1 For Windows 98SE Users:

The message, "Please insert the disk labeled 'Windows 98 Second Edition CD-ROM',....." is displayed. Click [OK].



- 1) The message "The file 'kstvtune.ax' on [Unknown] cannot be found..." is displayed.
  - Enter "C:\Windows\system" for Windows 98SE.
  - Enter "C:\Windows\options\CABS" for Windows Me.
  - If the "kstvtune.ax" file is missing in one of the 2 above-mentioned folders, insert the OS CD-ROM and assign the path.
- 2) The message "The file 'ksclockf.ax' on [Unknown] cannot be found..." is displayed.
  - Enter "C:\Windows\system".
  - If the "ksclockf.ax" file is missing in the above mentioned folder, insert the OS CD-ROM and assign the path.
- 3) The message "MTDV98M3.pdr is not found" is displayed.
  - Enter "C:\Windows\system\IOSUBSYS".
- 4) The message "MTDV98M3.sys is not found" is displayed.
  - Enter "C:\Windows\SYSTEM32\DRIVERS".
  - You may click [Browse] to look for and assign the path.

## ■ Connecting the Personal Computer and Camcorder

Please install the USB Driver first before connecting the Camcorder to your Personal Computer with the USB Cable.

Before making these connections, turn off all devices which are to be connected.

- When using the USB Connection Kit, use of the AC Adaptor is recommended for the power supply of the Camcorder.

### ■ For Using Built-in SD Drive (For PV-GS12/PV-GS14/PV-GS15)

By connecting the Camcorder and Personal Computer with the USB Cable, you can transfer still images saved on a Memory Card directly to your Personal Computer.

#### (For Windows)

- 1 Insert the Memory Card into the Camcorder.
- 2 Set the Camcorder to PC Mode.

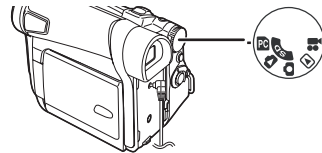

- 3 Connect the Camcorder to your personal computer with USB Cable.

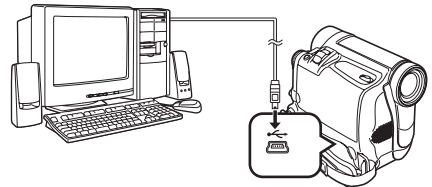

- It enters PC Connecting Mode.

- 4 Open [My Computer] and click [Removable Disk] ① (For Windows 98SE/Me/2000 users). Click [Open folder to view files using Windows Explorer] ② and then [OK] (For Windows XP users).



[Windows 98SE/Me/2000]



[Windows XP]

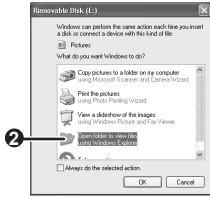

- You can view images stored on the Memory Card and also save them to your hard disk.
- Please do not change file or folder names on the Personal Computer. The images on the Memory Card may not be able to be viewed on the Camcorder.

**(For Macintosh)**

**OS:**

Mac OS X v 10.1 – X v 10.2

**CPU:**

iMac, iBook or Power Book G4, Power Mac G4 or Power Mac G5

**RAM:**

64 MB or more

**1 Insert the Memory Card into the Camcorder.**

**2 Set the Camcorder to PC Mode.**

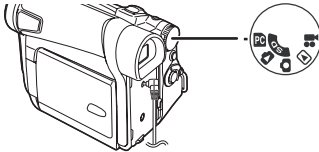

**3 Connect the Camcorder to your Macintosh with USB Cable.**

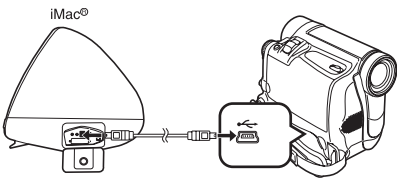

**4 Double click the “NO\_NAME” icon.**

- You can view images stored on the Memory Card and also save them to your hard disk.
- Please do not change file or folder names on the Personal Computer. The images on the Memory Card may not be able to be viewed on the Camcorder.

**To disconnect USB cable safely**

**(For Windows)**

If USB Cable is disconnected while computer is on, error dialog may appear. In such case click [OK] and close the dialog box. By following the steps below you can disconnect the cable safely.

**1 Double click the  icon in task tray.**

- Hardware disconnect dialog appears.



**2 Select [USB Mass Storage Device]  and click [Stop].**

**3 Verify [Matshita DVC USB Device] is selected and click [OK].**



- You can safely disconnect the cable.

**Note on the driver name  displayed**

The driver name displayed will differ depending on your OS, operating environment and the mode of the Camcorder.

**Windows XP/2000:**

- When the Camcorder is in Tape Recording mode or Tape Playback Mode:

[Panasonic DVC USB-SERIAL Driver for WinXXXX (COM X)] (The numeral designation after “Win” will differ depending on the OS. The numeral after “COM” will differ depending on the operating environment of your personal computer.)

- When the Camcorder is in PC Mode:

[USB Mass Storage Device] or [Panasonic DV DISK Port Driver]

**Windows Me:**

- When the Camcorder is in PC Mode:

[USB Disk]

- Some OS, such as Windows 98SE, may not show the icon indicating that you may safely disconnect in task tray. (OS may be set not to  show) Make sure Camcorder’s Card Access lamp is off and disconnect the cable. Also, with Windows Me, the icon will not be displayed when in Tape Recording Mode or Tape Playback Mode.

**CAUTION:**

If you disconnect the USB Cable while the Card Access Lamp is on, it may damage the Card data.

**(For Macintosh)  
Removing the USB Cable safely for  
Macintosh**



- ❶ Drop the [NO\_NAME] icon which appeared when you connected the Camcorder with the USB Cable into the recycle bin, then disconnect the USB Cable.

If the above operation is not performed correctly, when data is copied from the personal computer to an SD Memory Card, the copied data may be damaged.

Even when the following operations are performed, the same results will occur as when the USB Cable is removed (above). Therefore, it is imperative that the above operation ❶ is completed before proceeding.

- When Camcorder power is turned OFF.



- When SD Memory Card is removed.



**Using as a Web Camera**

If the Camcorder is connected to your personal computer, you can send video and sound from the Camcorder to the other parties via the network.

- Do not connect the USB Cable until the WebCam Driver is installed.

**This feature can be used only if both parties are using the same operating system. Please see chart below.**

[Send]		[Receive]	[Software]
Windows XP	<--OK-->	Windows XP	Windows Messenger
Windows XP	<--NG-->	Windows 98SE/Me/2000	
Windows 98SE/Me/2000	<--OK-->	Windows 98SE/Me/2000	MSN Messenger

**■ Operating environment**

**OS:**

IBM PC/AT compatible personal computer with preinstalled;  
Microsoft Windows XP Home Edition/Professional (In this case of Windows XP, SP1 or later is needed.)  
Microsoft Windows 2000 Professional  
Microsoft Windows Me (Millennium Edition)  
Microsoft Windows 98 Second Edition

**CPU:**

Intel Pentium II/Celeron 300 MHz or higher (including compatible CPU)

**RAM:**

32 MB or more (64 MB or more recommended) (128 MB or more required for Windows XP)

**Free hard disk space:**

At least 250 MB or more

**Ports:**

USB Jack

**To use the Camcorder as a Web Camera, the additional minimum requirements must be met.**

**Graphic display:**

High Color (16 bit or more)  
Desktop resolution of 800 x 600 pixels or more

**Communication Speed:**

56 kbps or faster is recommended.

**Necessary software:**

Windows Messenger 5.0 or later (Windows XP)  
MSN Messenger (Windows 98SE/Me/2000)

**Other requirements (to send/receive audio):**

Sound card  
Speaker or headphones

**To use the Camcorder as a Web Camera, the following conditions must be met.**

- To upgrade Windows XP to SP1, click [Start] >> [All Programs] >> [Windows Update]. (Requires Internet connection.)
- You have direct dial-up connection capability to the Internet. Also, you and the other person(s) are in the same Network (LAN).
- Install the Windows Messenger (Windows XP) or MSN Messenger (Windows 98SE/Me/2000). If you have a version older than 5.0, please download the latest version (5.0 or later) from the Microsoft Home Page:  
<http://www.microsoft.com/>  
<http://www.msn.com/>  
(For download and installation instructions, please refer to Help on the Home Page.)
- If you are connected to the Internet through a firewall or a router, proper communication will not be possible.
- The installer is available only in English but can be used on operating systems using other languages.
- When DirectX9.0 is installed, applications supported by previous versions of DirectX may not run.

## ■ Installing WebCam Driver

1 Turn on the personal computer and start up Windows.

2 Insert the CD-ROM into the personal computer's CD-ROM drive.

- Quit all applications.
- The [Setup Menu] Screen appears.



[PV-GS15: Supplied] [PV-GS9/PV-GS12/PV-GS14: Optional Software]

3 Click the [WebCam Driver].

- The set up program starts running.

4 For Windows XP users:

Depending on your system environment, installation of "DirectX9.0b" may be required. Click [Yes] and continue with installation.

- After "DirectX9.0b" is installed, the computer will restart.
- Do not remove the CD-ROM.

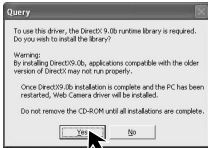

5 Finish installation by following the on-screen instructions.

- Click [Next] and proceed with installation.
- After completing the installation, click [Finish].

## ■ Connecting the Camcorder to Personal Computer (For Using as a Web Camera)

1 Set the Camcorder to Tape Recording Mode or Tape Playback Mode.

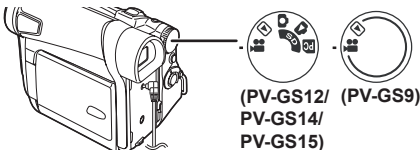

2 Set [CAMERA] or [PLAYBACK] >> [USB FUNCTION] >> [WEB CAMERA].

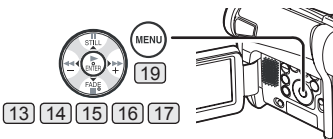

3 Connect the Camcorder to your personal computer with USB Cable.

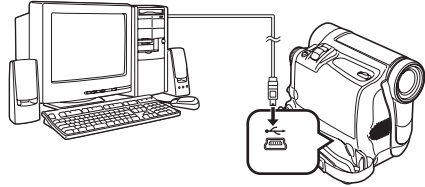

- "WEB" is displayed on the LCD Monitor of the Camcorder.
- When the Camcorder and personal computer (with Windows 2000) are connected via USB Cable, a message, such as the one below, is displayed. However, testing by the manufacturer has confirmed functionality of this Camcorder with Windows 2000. Click [Yes] and proceed.



- For Windows 98SE/Me users, "USB Audio Device" is required. Click [Next] and proceed.



- If you use Windows 98SE, the OS installation CD may be required.

4 Start the Windows Messenger (For Windows XP users) or MSN Messenger (For Windows 98SE/Me/2000 users).

- Click [Start] >> [All Programs (Program)] >> [Windows Messenger] or [MSN Messenger].
- When you use Windows XP, the other parties via the network have to use the Windows Messenger on Windows XP. When you use other than Windows XP, the other parties via the network have to use MSN Messenger on an OS other than Windows XP.
- If the Camcorder is used as a Web Camera, the quality of the video to be exchanged will depend on the Internet connection status.
- If the USB Cable is disconnected from the personal computer, the Web Camera mode is canceled.
- If the Camcorder is used as a Web Camera, video cannot be recorded onto a tape or a card.

## ■ Setting up the Windows Messenger

When starting the Windows Messenger for the first time, its setup screen is displayed. (However, the screen is not displayed if the Windows Messenger setup has already been done.) For more details, please read the corresponding Help file.

### 1 Click [Click here to sign in].

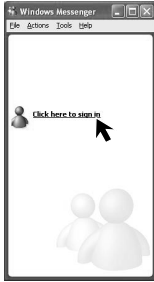

### 2 Select [.NET Messaging Service] and click [OK].



### 3 Click [Next] when the [.NET Passport Wizard] dialog appears.



### 4 Please carefully read the displayed contents and then proceed.

### 5 After the setup is completed, sign in and start the Windows Messenger.



### 6 Click on [Audio Tuning Wizard...] in the [Tools] menu to confirm that equipment is connected correctly.

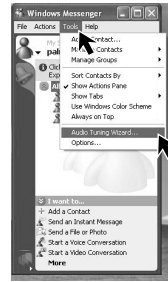

### 7 Select [USB Video Device] in the [Camera] menu.



### 8 Select [DVC] in the [Microphone] menu.



- For other information about Windows Messenger, please refer to Help.
- When access is finished, close Windows Messenger, then turn off the Camcorder. Finally, disconnect the USB Cable.
- If the Camcorder is used as Web Camera continuously for two hours, the communication is automatically shut OFF. In this case, restart Windows Messenger and set up the communication again.

## ■ Setting up the MSN Messenger

When starting the MSN Messenger for the first time, its setup screen is displayed. (However, the screen is not displayed if the MSN Messenger setup has already been done.) For more details, please read the corresponding Help file.

### 1 Click [Sign In].



**2 Type in your Sign-in name and password.**

- If you do not have your Sign-in name and password, click [Get one here].



**3 Please carefully read the displayed contents and then proceed.**

**4 After the setup is completed, sign in and start the MSN Messenger.**

**5 Click on [Audio Tuning Wizard...] in the [Tools] menu to confirm that equipment is connected correctly.**

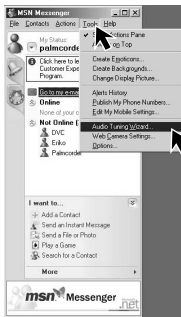

**6 Select [USB Audio Device] in the [Microphone] menu.**



**7 Click [Web Camera Settings...] in the [Tools] menu.**



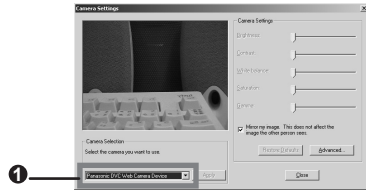

**8 Confirm the [Panasonic DVC Web Camera Device] is selected.**



- For other information about MSN Messenger, please refer to Help.
- If the Camcorder is used as a Web Camera continuously for two hours, the communication is automatically shut OFF. In this case, restart MSN Messenger and set up the communication again.
- When access is finished, close MSN Messenger, then turn off the Camcorder. Finally, disconnect the USB Cable.

**Using the DV STUDIO 3.1E-SE (Optional Software)**

Following Software is not supplied with the Camcorder;

- LSFT0577 (DV STUDIO 3.1E-SE) 
- K1HA05CD0005 (USB Cable) 

The Software allows you to capture a still image from your motion video on the tape and transfer to a PC. If you would like to order, please refer to page 74.

**Operating environment**

**OS:**

- IBM PC/AT compatible personal computer with preinstalled;
- Microsoft Windows XP Home Edition/Professional
- Microsoft Windows Me (Millennium Edition)
- Microsoft Windows 98 Second Edition

**CPU:**

Intel Pentium II/Celeron 300 MHz or higher (including compatible CPU)

**Graphic display:**

High Color (16 bit or more)  
Desktop resolution of 800 x 600 pixels or more

**RAM:**

32 MB or more (64 MB or more recommended) (128 MB or more required for Windows XP (256 MB or more recommended))

**Free hard disk space:**

At least 20 MB

**Ports:**

USB Jack

**Other requirements:**

Mouse

- The DV STUDIO 3.1E-SE cannot be operated on Windows 2000.
- When 2 or more USB devices are connected to a personal computer, or when devices are connected through USB hubs or by using extension cables, proper operation is not guaranteed.
- When connected to the keyboard USB Jack, normal function may not be possible.
- This instruction manual describes only the procedures for installation, connection and startup. Please read the PDF-based instructions for how to use the DV STUDIO 3.1E-SE.
- To view the installed operating instructions, Adobe Acrobat Reader 5.0 or higher is required. Please install Adobe Acrobat Reader from the CD-ROM (Optional Software).
- Before using for the first time, select [Readme] from [Start] >> [All programs (Programs)] >> [Panasonic] >> [DV Studio3], and read any supplementary details or updates.

### ■ Installing DV STUDIO 3.1E-SE (Optional Software)

#### 1 Turn on the personal computer and start up Windows.

#### 2 Insert the CD-ROM into the personal computer's CD-ROM drive.

- Quit all applications.
- The [Setup Menu] Screen appears.



#### 3 Click [DV STUDIO].

#### 4 Click [Next].

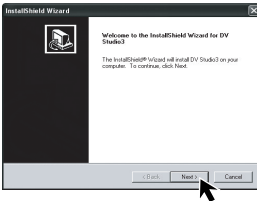

- After reading the displayed contents, please carry out the installation according to instructions.

#### 5 After the completion of setup, click on [Finish].

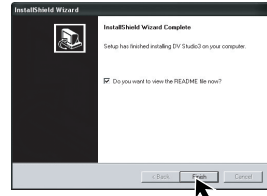

- Installation will be completed.
- Sample data is installed concurrently with the DV STUDIO 3.1E-SE software.

### ■ To Use DV STUDIO 3.1E-SE

- When using the USB Connection Kit, use of the AC Adaptor is recommended for the power supply of the Camcorder.

#### 1 Set the Camcorder to Tape Recording Mode or Tape Playback Mode.

- To capture images from a tape, set the Camcorder to Tape Playback Mode and insert a tape.
- To capture images viewed through the camera lens, set the Camcorder to Tape Recording Mode.

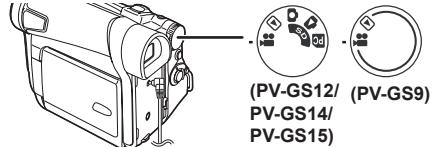

#### 2 Set [CAMERA] or [PLAYBACK] >> [USB FUNCTION] >> [DV STUDIO].

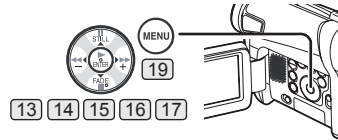

#### 3 Connect the Camcorder to your personal computer with USB Cable.

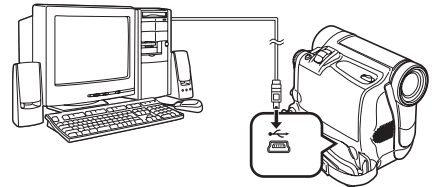

**4 Select [Start] >> [All Programs (Programs)] >> [Panasonic] >> [DV Studio3] >> [DV Studio3].**

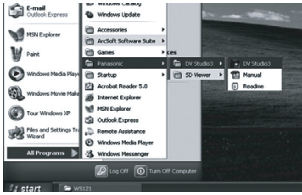

- If a short-cut icon has been created on the desktop during installation, it is also possible to start by double-clicking on the icon.
- For other information about DV STUDIO 3.1E-SE Software, please refer to Help.

**Using the ArcSoft Software (PV-GS15: Supplied)**

There are 2 types of image editing software in the ArcSoft Software package.

**1 PhotoBase 4 (Windows), PhotoBase 2 (Mac)**



- Create albums of image, video, audio, and other electronic files for easy viewing, retrieval, and management.

**2 PhotImpression 4 (Windows, Mac)**



- Easy-to-use photo editing program to edit, enhance, retouch or add special effects to any image. Also offers creative solutions for making greeting cards and calendars.

**Operating environment (For Windows)**

**OS:**

IBM PC/AT compatible personal computer with pre-installed;  
 Microsoft Windows XP Home Edition/Professional  
 Microsoft Windows 2000 Professional  
 Microsoft Windows Me (Millennium Edition)  
 Microsoft Windows 98 Second Edition

**CPU:**

Pentium II-based PC or equivalent (1)  
 Pentium-based PC or equivalent (2)  
 (Pentium II 300 MHz or higher recommended)

**Graphic display:**

High Color (16 bit or more)  
 Desktop resolution of 800 x 600 pixels or more

**RAM:**

64 MB or more (128 MB or more recommended)

**Free hard disk space:**

At least 625 MB

**Other requirements:**

Mouse

**(For Macintosh)**

**OS:**

Mac OS 9 – X

**CPU:**

iMac, iBook or Power Book G4, Power Mac G4 or Power Mac G5

**Graphic display:**

High Color (16 bit or more)  
 Desktop resolution of 800 x 600 pixels or more

**RAM:**

64 MB or more (128 MB or more is recommended)

**Free hard disk space:**

At least 300 MB

- This instruction manual describes only the procedures for installation, connection and startup. Please read the Help messages of your software for how to use the ArcSoft Software.

**Installation of ArcSoft Software**

**(For Windows)**

**1 Turn on the personal computer and start up Windows.**

**2 Insert the CD-ROM into the personal computer's CD-ROM drive.**

- Quit all applications.
- The [Setup Menu] Screen appears.



- 3 Click **[ArcSoft]**.
- 4 Select the desired language on the **[Choose Setup Language]** dialog, and click **[OK]**.



- **Installation begins.**
  - After reading the displayed contents, please carry out the installation according to instructions.
  - If a language other than the OS language is selected, the characters may not be presented correctly.
- 5 When the component selection screen is displayed, check the software to be installed and click **[Next]**.

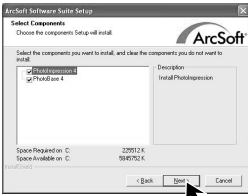

- 6 After the completion of setup, click on **[Finish]**.

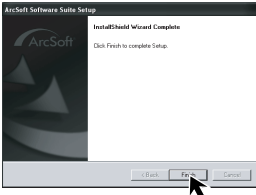

- Installation will be completed.

**(For Macintosh)**

- 1 Turn on computer and start up Macintosh.
- 2 Insert the CD-ROM into the CD-ROM drive.
- 3 Double click the **Panasonic** icon.



- 4 Double click **[ArcSoft]** folder.



- 5 Double click **[PhotoBase]** or **[PhotoImpression]** folder.
- 6 Double click **[English]** or **[French]** folder.
- 7 Double click **[PhotoBase Installer]** or **[PhotoImpression Installer]**.
  - Installation begins.
- 8 Follow the instructions on the computer screen until the installation is complete.

■ **To start ArcSoft Software (For Windows)**

- 1 Select **[Start] >> [All Programs (Programs)] >> [ArcSoft Software Suite] >> [PhotoBase 4] or [PhotoImpression 4]**.
  - For other information about ArcSoft Software, please refer to Help.

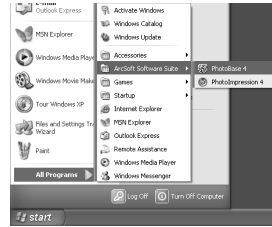

**(For Macintosh)**

- 1 Double-click the **[PhotoImpression]** or **[PhotoBase]** icon on the desktop.
  - For other information about ArcSoft Software, please refer to Help.

**For Information on ArcSoft Software:**

TEL: 1-510-440-9901  
 Web Site: [www.arcsoft.com](http://www.arcsoft.com)

***If you no longer need software or driver (Uninstall)***

The screens may vary with the type of the OS.

- 1 Select **[Start] (>> [Settings]) >> [Control Panel]**, select the software or the driver from **[Add/Remove Programs]** to uninstall.
  - Uninstalling steps may vary depending on the OS. Please refer to the user manual of your OS.
- 2 After software or driver is uninstalled, please restart your computer.



## Notes

- Macintosh is a registered trademark of Apple Computer, Inc. ArcSoft, the ArcSoft logo, ArcSoft PhotoImpression 4 and ArcSoft PhotoBase 4 are trademarks of ArcSoft, Inc.
- Microsoft® Windows®, Windows Messenger®, MSN Messenger® and DirectX® are either trademarks or registered trademarks of the Microsoft Corporation in the United States and/or other countries.
- Intel®, Pentium® and Celeron® are the registered trademarks or trademarks of the Intel Corporation.
- All other names, company names, product names, etc. in these instructions are the trademarks or registered trademarks of their respective corporations.
- The names of the products you are using may differ from the names given in the text. Depending on the operating environment and other factors, the contents of the screens used in these instructions may not necessarily match what you will see on your screen.
- Although the screens in these Operating Instructions are shown in English for the sake of example, other languages are supported as well.
- In this Manual, the Panasonic make digital video camera with USB Jack is referred to as Camcorder.
- These instructions do not cover the basic operations of the personal computer or define any terms. For this information, refer to the Operating Instructions which accompany your personal computer.
- Do not disconnect USB Cable while the operation light of Camcorder is on. It may freeze the software or destroy the data in transfer.
- We recommend using the AC adaptor as the power source for the Camcorder when using USB Connection Kit. Data may be lost if the battery power is lost while transferring data.
- If the Camcorder is used as a Web Camera while virus checking software is running, the Camcorder's operation may stop midway through. In this case, exit the Windows Messenger or MSN Messenger, reconnect the Camcorder and restart the Windows Messenger or MSN Messenger.
- Do not delete the folders in the memory card such as picture folder. Memory card may not be recognized if folders are deleted.
- When the Camcorder is connected to a personal computer in PC Mode, it will not be possible to change to other modes. To change modes, disconnect the USB cable, switch the Camcorder Mode Dial, then reconnect the USB cable.
- When the Tape Recording Mode of the Camcorder is switched to the PC Mode, a warning message may be displayed. You may simply ignore it.

- When you are using Windows XP or Windows 2000, you may install or uninstall this software after logging ON by setting the user name to Administrator or to a user name having equivalent authority.
- If you install the USB Driver after the USB Cable is connected, or if you do not follow these Operating Instructions, the Camcorder will not be recognized correctly. In this case, delete the USB Driver from [Device Manager] as described below, uninstall the USB Driver, and re-install it.
  - With the Camcorder and personal computer connected via a USB Cable, open the [Device Manager]. Right-click [!DVC] ❶ in [Ports] or [Other devices], and select [Uninstall]. ([!DVC] ❶ will differ depending on the OS or operating environment of your personal computer.)

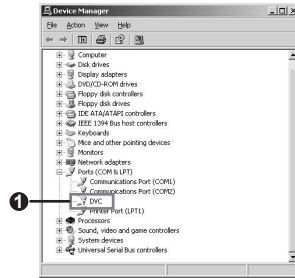

## ■ About the SD Memory Card and MultiMediaCard (For PV-GS12/PV-GS14/PV-GS15)

### SD Memory Card

The SD Memory Card (PV-GS15: Supplied, PV-GS12/PV-GS14: Optional) is virtually the same size as a MultiMediaCard. It is an external memory card that is available in larger capacities. It has a write protect switch to prevent data writing and card formatting, as well as a copyright protection function.

- SD Logo is a trademark.

### MultiMediaCard (Optional)

The MultiMediaCard is a compact, lightweight and removable external memory card.

- All other company and product names in the operating instructions are trademarks or registered trademarks of their respective corporations.

### Files recorded on a SD Memory Card or MultiMediaCard

It may not be possible to play back the files on this Camcorder recorded on and created by other equipment or vice versa. For this reason, check the compatibility of the equipment in advance.

### ■ About the compatibility of the card files (For PV-GS12/PV-GS14/PV-GS15)

Data files recorded on an "SD Memory Card" or a "MultiMediaCard" by this Camcorder conform with DCF (Design rule for Camera File system) established by JEITA (Japan Electronics and Information Technology Industries Association).

- If you attempt to play back files recorded with this Camcorder on other equipment or to play back files recorded with other equipment on this Camcorder, you may not be able to play them back. Please check the compatibility with the other equipment in advance.

### ■ About the folder structure when using the Memory Card in a personal computer (For PV-GS12/PV-GS14/PV-GS15)

- When a Card with data recorded on it is inserted into a personal computer, folders will be displayed as in the figure.

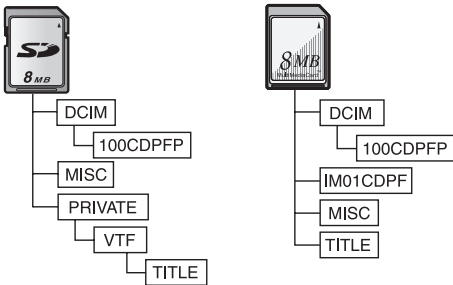

[100CDPFP]:

The images (IMGA0001.JPG, etc.) in this folder are recorded in the JPEG format.

[MISC]:

Files in which DPOF Data has been set to the image are in this folder.

[TITLE]:

This contains the data of the original titles (USR00001.TTL, etc.).

- [DCIM], [IM01CDPF], [PRIVATE], [VTF], etc. are necessary items in the folder structure. They have nothing to do with actual operations.
- In the Card Mode, the Camcorder automatically saves file numbers (IMGA0001.JPG, etc.) along with the images. The file numbers are recorded with each image as consecutive numbers.
- When using software without an indication function, indication data, such as date, are not displayed. Depending on the software in use, the date and the time may not be displayed correctly.

- The memory capacity indicated on the SD Card label corresponds to the total card capacity. Some of this capacity is used to protect and manage the copyright data, and not all capacity is available as a conventional memory for a Camcorder, Personal Computer or others. Capacity that can be used as conventional memory:



8 MB Card: about 6,800,000 bytes

## Others

**Indications**









Various functions and the Camcorder status are shown on the screen.

























: Remaining Battery Power

- When the battery power becomes low, the Indication changes. When the battery is discharged completely, the  (  ) Indication flashes.

R0:45: Remaining Tape Time

- Remaining tape time is indicated in minutes. (When it reaches less than 3 minutes, the indication starts flashing.)

	Tape Recording Mode (p. 24)
	Tape Playback Mode (p. 35)
	Card Recording Mode (p. 25) (For PV-GS12/PV-GS14/PV-GS15)
	Picture Playback Mode (p. 38) (For PV-GS12/PV-GS14/PV-GS15)
	PC Mode (p. 48) (For PV-GS12/PV-GS14/PV-GS15)
CINEMA:	Cinema Mode (pp. 29-30)
D.ZOOM:	Digital Zoom (p. 27)
MULTI:	Multi Mode (p. 33)
P-IN-P:	P-IN-P Mode (p. 33)
WIPE:	Wipe Mode (p. 33)
MIX:	Mix Mode (p. 33)
STROBE:	Strobe Mode (p. 33)
TRAIL:	Trailing Effect Mode (p. 33)
MOSAIC:	Mosaic Mode (p. 33)
MIRROR:	Mirror Mode (p. 33)
STRETCH:	Stretch Mode (p. 33)
SLIM:	Slim Mode (p. 33)
NEGA:	Negative Mode (p. 33)
SEPIA:	Sepia Mode (p. 33)
B/W:	Black & White Mode (p. 33)
SOLARI:	Solarisation Mode (p. 33)
ZOOM:	Playback Zoom (p. 37)
SP:	Standard Play Mode (Recording Speed Mode) (p. 23)
LP:	Long Play Mode (Recording Speed Mode) (p. 23)
INDEX:	Index signal recording (p. 37)
S 1:	Search Number (p. 37)
5X:	Zoom Magnification Indication (pp. 27-28)
AUTO:	Automatic Mode (p. 24)
MNL:	Manual Mode (pp. 30-32)
EIS:	Image Stabilizer (p. 28)
12 bit, 16 bit:	Audio Recording Mode (p. 23)
MF:	Manual Focus (p. 32)
	Back Light Mode (p. 29)
	Sports Mode (Program AE) (p. 30)
	Portrait Mode (Program AE) (p. 30)

	Low Light Mode (Program AE) (p. 30)
	Spotlight Mode (Program AE) (p. 30)
	Surf & Snow Mode (Program AE) (p. 30)
REC:	Recording (p. 24)
PAUSE:	Recording Pause (p. 24)
	Self-Timer Recording (p. 27)
	Playback (p. 35)
	Still Playback (p. 36)
	Fast-forward/Cue Playback (p. 35)
	Rewind/Review Playback (p. 35)
	Slow Motion Playback (p. 36)
	Still Advance Playback (p. 36)
	Index Search (p. 37)
CHK:	Recording Check (p. 24)
A.DUB 	Audio Dubbing (p. 44)
A.DUB 	Audio Dubbing Pause (p. 44)
BLANK:	Blank Search (p. 24)
R 	Repeat Playback (p. 64)
2X 	Variable Speed Search (p. 36)
1/500:	When you adjust shutter speed manually, this indication appears. (p. 32)
SLIDE 	Slide Show Playback (p. 39)
SLIDE 	Slide Show Playback Pause (p. 39)
F2.4:	When you adjust the F Number manually, this indication appears. (p. 32)
AWB:	Automatic White Balance Mode (p. 30)
	White Balance Adjustment Mode (p. 30)
	Outdoor Mode (p. 30)
	Indoor Mode (recording under incandescent lamp) (p. 30)
MAGICPIX:	MagicPix Function (p. 29)
Z.MIC:	Zoom Microphone (p. 27)
WIND CUT:	Wind Noise Reduction (p. 29)
	Progressive Photoshot Mode (p. 25)
	Soft Skin Mode (p. 29)
PICTURE:	Picture (p. 39)
TITLE:	Title picture (p. 40)
VOLUME:	Volume adjustment (p. 35)
3:30:45AM:	Date/Time Indication (p. 60)
N (F, E):	Photoshot Picture Quality (during Photoshot recording) [F] means Fine, [N] means Normal and [E] means Economy. (p. 25)
0:	Remaining Number of Photoshot pictures
	RapidFire Consecutive Photoshot Recording (p. 26)
	Lock Setting (p. 41)
	LED Video Light is on. (p. 26)

**GAINUP:** Gain up Mode (p. 26)  
 ● (White): DPOF Setting completed (set to 1 or more picture) (p. 41)

**[640]:** [640 x 480] Image size

- For images not recorded with this Camcorder, the size display is determined as follows according to the number of horizontal pixels.

**[640]:** 640 or more, less than 800 (The size is not displayed at under 640 pixels.)

**[SVGA]:** 800 or more, less than 1 024

**[XGA]:** 1 024 or more, less than 1 280

**[SXGA]:** 1 280 or more, less than 1 600

**[UXGA]:** 1 600 or more, less than 2048

**[QXGA]:** 2 048 or more

**[PICTURE] (Cyan):** Photoshot Mode

**[PICTURE] (Red):** While Photoshot recording is activated

**[PICTURE] (Green):** While the Card being read

**[PICTURE] (Red):** No Card (Still Picture Mode)

## ■ To Change the Counter Display Mode

By changing [C.DISPLAY] on the [DISPLAY] Sub-Menu, you can change the Counter Display Mode to Tape Counter Indication [COUNTER] (0:00.00), Memory Counter Indication [MEMORY] (M0:00.00), and Time Code Indication [TIMECODE] (0h00m00s00f). (p. 21) By repeatedly pressing the [DISPLAY] Button on the Remote Control, you can change the Counter Display Mode.

## ■ To Display Date/Time Indication

To display Date/Time Indication, set the appropriate Date/Time in [DATE/TIME] on the [DISPLAY] Sub-Menu. (p. 21)

You can also press the [DATE/TIME] Button of the Remote Control repeatedly to display or change the Date/Time Indication.

## ■ To Change the Display Mode

By changing [DISPLAY] on the [DISPLAY] Sub-Menu, you can change the Display Mode to All Function Display [ALL] and Minimum Display [OFF]. (p. 21)

## ■ Progressive Photoshot

You cannot use the Progressive Photoshot Function in the following cases.

### When using Tape Recording Mode

- Digital Effect Modes in [EFFECT1]
- Digital Zoom [D.ZOOM]
- 1/750 s or faster shutter speed
- When brightness is insufficient
- When the MagicPix Function is ON
- When the Portrait is used

### When using Card Recording Mode

- When brightness is insufficient
- When the MagicPix Function is ON

## Initializing the Modes

You can change the Menu settings back to the shipping condition.

### 1 Set [INITIAL] >> [INITIAL SET] >> [YES].

- The initializing takes a little while.
- After the initializing is completed, the [COMPLETED] Indication appears with beeps.
- Initializing will not erase a clock setting (p. 23) that has been adjusted.

## Warning/Alarm Indications

If any one of the following indications lights up or flashes, please check the condition of the Camcorder.

 **DEW (DEW DETECTED/EJECT TAPE):**  
Condensation has occurred. (pp. 66-67)

 **(CHECK REC TAB):**

The accidental erasure prevention slider on the inserted Cassette is open (that is, set to [SAVE]). You are attempting Audio dubbing or Digital dubbing on a Tape while setting the accidental erasure prevention slider to [SAVE].

 **(TAPE NOT INSERTED):**

No Cassette in inserted. (p. 17)

 **(LOW BATTERY):**

The Battery is low. Recharge it. (p. 15)

 **:**

The built-in battery is low. (p. 23)

 **(NEED HEAD CLEANING):**

The video heads are dirty. (p. 67)

 **END (TAPE END):**

The tape came to an end during recording.

**REMOTE (CHECK REMOTE MODE):**

Wrong Remote Control Mode has been selected. (p. 15)

**UNPLAYABLE TAPE (OTHER FORMAT):**

You are attempting to play back a tape section that has been recorded with a different TV system.

**UNABLE TO A.DUB (LP RECORDED):**

Because the original recording was done in LP Mode, audio dubbing cannot be performed.

**INCOMPATIBLE TAPE:**

This cassette is incompatible.

**PUSH THE RESET SWITCH:**

Irregular mechanism is detected. Press the [RESET] Button (p. 70). This may solve the problem.

**CARD FULL:**

Card does not have sufficient memory remaining. Select Picture Playback Mode and delete unnecessary files.

**NO CARD:**

Card is not inserted.

**NO DATA:**

There are no recorded files in the card.

**UNPLAYABLE CARD:**

You are attempting to play back data which is not compatible with this Camcorder.

**CARD ERROR:**

The Card is not compatible with this Camcorder.

**COPY INHIBITED:**

Because the medium is protected by a copy guard, images cannot be recorded correctly.

**INCORRECT OPERATION:**

The Recording Start/Stop Button was pressed without connecting the USB cable to the PC in Picture Playback Mode.

**CANNOT USE USB****CHANGE MODE:**

The USB cable is connected to the Camcorder in Card Recording Mode or Picture Playback Mode.

**CANNOT OPERATE:**

You are attempting to record pictures on a Card while connecting the USB cable to the Camcorder in Tape Recording/Playback Mode.

**UNABLE TO WRITE****(MULTI RECORDING):**

The [PHOTO SHOT] Button is pressed when you are recording pictures on a Tape while setting the Digital Effect [MULTI] of [EFFECT1].

**UNABLE TO WRITE:**

The Recording Start/Stop Button is pressed when you are recording still pictures on the Card.

**CASSETTE DOOR OPENED:**

Close the Cassette Compartment Cover before recording.

**NO TITLE:**

Titles are not recorded.

**UNABLE TO WRITE****(WIDE MODE):**

You are attempting to record pictures of S1 signal (with aspect ratio 16:9) by pressing the [PHOTO SHOT] Button.

**FILE LOCKED:**

You are attempting to erase protected files.

**CARD LOCKED:**

The write protection switch on the SD Memory Card is set to [LOCK].

**DISCONNECT USB CABLE:**

You are attempting to turn the Mode Dial or turn the Camcorder off in PC Mode while connecting the USB cable to the Camcorder.

**Notes and Hints****Concerning the Power Supply**

- When the Camcorder has been used for a long time, the Camera body becomes warm, but this is not a malfunction.
- If the [CHARGE] Lamp does not light up although the Battery is attached to the AC Adaptor, detach the Battery and reattach it.

**Inserting/Removing the Cassette**

- In the case of using a previously recorded Cassette, you can use the Blank Search Function (p. 24) to find the position where you want to continue recording.
- If a new Cassette is inserted, rewind to the beginning of the tape before starting recording.
- When inserting the cassette, make sure it faces in the right direction and then push it in until it stops.
- When the Cassette Holder is in action, do not touch anything except the [PUSH] mark.
- When closing the Cassette Compartment Cover, do not get anything caught in the cover, such as a cable of an optional stereo microphone (For PV-GS14/PV-GS15).

**Alarm Sounds**

When [BEEP SOUND] on the [INITIAL] Sub-Menu on the [TAPE RECORDING MENU] is set to [ON], confirmation/alarm beeps are issued as follows.

**1 Beep**

- When you start recording
- When you switch the [OFF/ON] Switch from [OFF] to [ON]

**2 Beeps**

- When you pause recording

**2 Beeps 4 times**

- If you perform a wrong operation before or during recording.

**Recording Check**

- For Recording Check, the recording speed mode (SP/LP) must be the same as the mode used for the recording. If different, playback images will be distorted.

**Recording on a Card**

- Even if the [SHTR EFFECT] is set to [ON], the Shutter Effect cannot be recorded on the picture.
- When the color of the screen changes or blurs, adjust the shutter speed manually to 1/60 or 1/100.

**Photoshot**

- Photoshot Recording results in slightly inferior image quality.

**RapidFire Consecutive Photoshot**

- One more still picture may be recorded after you release the [PHOTO SHOT] Button.
- The RapidFire Consecutive Photoshot and Title Function cannot be used simultaneously.

- When the [SELF TIMER] is set to [ON], the Camcorder records the maximum number of recordable pictures depending on the [BURST MODE] setting.
- When using a card formatted by other equipment, intervals between recorded pictures may become large.
- If you repeatedly record or erase pictures, intervals between recorded pictures may become large. In this case, back up your important data on a PC, and format your card using this Camcorder.

### ■ Recording with the Built-in LED Video Light

- The subject should be within 4.9 feet (1.5 metres) of the Camcorder.
- Using the LED Video Light reduces battery time.
- Set the LED Video Light to off when not in use.
- Do not look directly into the light.
- If the LED Video light is used with a Conversion lens attached, a slight vignetting (darkening around edges) effect occurs on the screen.
- Using the MagicPix Function at the same time will make conditions even brighter.
- The Video Light brightens images recorded in a dimly-lit place, however we recommend using it in a bright place in order to obtain high quality images.

### ■ Quick Start

- During the Quick Start Standby Mode, a minute amount of electricity is consumed.
- When the Camcorder is left in the Recording Pause Mode for 5 minutes, it will be turned into the Quick Start Standby Mode. To turn the Camcorder on again, set the [OFF/ON] Switch to [OFF] and then set it to [ON] again. (The Quick Start Mode will be restored.)
- This Function is not activated in the following case:
  - Neither a card nor a tape has been inserted while the Tape/Card Recording Mode is set.
- In the following cases, Quick Start is canceled during the Quick Start Standby Mode.
  - Operate the Mode Dial
  - The Battery is replaced
- If the [QUICK START] Button is pressed and held for approximately 2 seconds during the Quick Start Standby Mode, the Lamp will go off and the Camcorder will be turned off.
- If the Camcorder is not operated for approximately 30 minutes when the Quick Start Recording Lamp lights, the Lamp will go off and the Camcorder will be completely turned off.
- In the Automatic White Balance Mode, the color may be recorded unnaturally at the beginning of the recording.
- The zoom magnification differs from when it is in the Quick Start Standby Mode and when the recording starts.

### ■ Self-timer Recording

- When [BEEP SOUND] on the [INITIAL] Sub-Menu is set to [ON], the beep sound will be emitted along with the Recording Lamp flashing in the Self-timer Standby Mode.
- By operating the [OFF/ON] Switch, Recording Start/Stop Button or Mode Dial, the Self-timer Standby Mode is canceled.

### ■ Zoom In/Out Functions

- When you are zooming in on a faraway subject, a sharper focus is achieved if the recording subject is 4 feet (1.2 meters) or further from the Camcorder.

### ■ Zoom Microphone Function

- The Zoom Microphone Function may not work effectively if the surrounding noise is too loud.
- It does not work with the external microphone (For PV-GS14/PV-GS15).

### ■ Digital Zoom Functions

- As the magnification of digital zoom increases, the quality of image may deteriorate.
- White balance cannot be set in the digital zoom range.

### ■ Image Stabilizer Function

- The Image Stabilizer Function does not operate in a dimly lit place. In this case, the [EIS] Indication flashes.
- Under fluorescent lighting, image brightness may change or colors may not look natural.
- After-images may appear.
- When a tripod is used, it is recommended that you turn the Image Stabilizer off.
- Within the digital zoom range, or when recording with a conversion lens attached, the Image Stabilizer Function may not work effectively.

### ■ Backlight Compensation Function

- When setting the Iris manually, the Backlight Compensation Function does not work.
- By operating the [OFF/ON] Switch, the Backlight Compensation Function is canceled.

### ■ MagicPix Function

- In a bright place, such as outdoors, the recorded picture may become whitish.
- In a dark place, the recorded picture is presented in a time-lapse-like manner.
- Adjust the Focus manually.
- The Progressive Photoshot Function is automatically turned off.
- The RapidFire Consecutive Photoshot Function cannot be used.
- White Balance cannot be set.
- The shutter speed cannot be adjusted.
- The Image Stabilizer, Program AE, Multi Title Screen, or Digital Effect Modes in [EFFECT1] cannot be set.
- When recording with the MagicPix Function, it is recommended that you use a tripod.

- The MagicPix Function makes the signal charging time of CCD longer up to 30 times longer than usual, so that dark scenes that are invisible to the naked eyes can be recorded brightly. For this reason, a bright dots may be seen, but this is not a malfunction.
- The Image Stabilizer Function does not work. In this case, the [EIS] Indication flashes.
- The Soft Skin Function and the Backlight Compensation Function cannot be changed.

### ■ Wind Noise Reduction Function

- It does not work with the microphone on an external microphone.
- When it is set to [ON], directivity of microphone is regulated depending on the strength of wind to reduce wind noise.

### ■ Cinema Function

- Using the Cinema Mode does not widen the recording angle.
- When images are displayed on a TV screen, the Date/Time Indication may be erased in some cases.
- Depending on the TV, the picture quality may be deteriorated.
- The Cinema Mode is canceled when a Title is displayed.
- The Cinema Mode and the Title Creation cannot be used simultaneously.
- Using the Cinema Mode deactivates [MULTI] and [P-IN-P] of [EFFECT1].
- Depending on the software in use, the imported Cinema picture may not be displayed correctly.

### ■ Program AE

- If any of the Program AE Modes are selected, you cannot adjust the shutter speed (p. 32) or iris (p. 32).
- Using the MagicPix Function cancels any of the Program AE modes.
- Using the Light Function cancels any of the Program AE modes.

### Sports Mode

- During normal playback, the image movement may not look smooth.
- Because the color and brightness of the playback image may change, avoid recording under fluorescent light, mercury light or sodium light.
- If you record a subject illuminated with strong light or a highly reflective subject, vertical lines of light may appear.
- If the light is insufficient, the [  ] Indication flashes.

### Sports Mode/Portrait Mode

- If you record a still picture in Progressive Photoshot Mode, the brightness and hue of the recorded still picture may become unstable.
- If this mode is used for indoor recording, playback images may flicker.

### Low Light Mode

- Extremely dark scenes may not be able to be made brighter to a satisfactory degree.

### Spotlight Mode

- With this mode, recorded images may become extremely dark.
- If the subject is extremely bright, its recorded image may become whitish.

### Surf & Snow Mode

- If the subject is extremely bright, its recorded image may turn out to be whitish.

### ■ White Balance

#### In the following cases, you cannot change White Balance:

- When you set [EFFECT2] to [SEPIA] or to [B/W].
- When you set the Zoom higher than 20X (PV-GS9/PV-GS12)/ 22X (PV-GS14)/24X (PV-GS15)
- During Digital Still Picture Mode
- When you display a Menu
- When you use the MagicPix Mode

#### In the following cases, the [ ] Indication flashes:

- The flashing indicates that the previously adjusted White Balance setting is still set. This setting will be kept until White Balance is adjusted again.
- You may not be able to achieve correct White Balance Adjustment manually under weak illumination.

### ■ Manual Shutter Speed Adjustment

- You may see vertical lines of light in the playback image of a brightly shining subject or highly reflective subject.
- During normal playback, movement in the images may not look smooth.
- Because the color and brightness of the playback image may become unstable, avoid recording under fluorescent light, mercury light or sodium light.
- If you are using MagicPix Mode (p. 29) or Program AE Mode (p. 30), you cannot adjust the shutter speed.

### ■ Manual Iris Adjustment

- Depending on zoom magnification, there are iris values that will not be displayed.
- If you are using MagicPix Mode (p. 29) or Program AE Mode (p. 30), you cannot adjust the iris.
- If you attempt to adjust the Shutter Speed after setting the Iris, the value set for the Iris will be canceled.

### ■ Digital Effect Functions

- If you have set [EFFECT2] to [B/W] or [SEPIA], changing the selected White Balance Mode is not possible. (pp. 30-31)
- Setting the Cinema Mode cancels the Picture-in-Picture Mode and the Multi-Picture Mode.
- During the Digital Still Picture Mode, the Digital Effect Functions cannot be set.

In the following cases, using the [EFFECT1] on the [DIGITAL] Sub-Menu is not possible.

- When the MagicPix Mode and Light are set (pp. 26, 29)

In the following cases, using the Digital Effect Function is not possible.

- Title in

#### Multi-Picture Mode

- If the [MULTI] Button is pressed while self-recording Mirror Mode (p. 26) is used, the still picture is displayed from the upper right corner of the screen, but, in reality, the picture is recorded from the upper left corner as usual.
- The quality of Multi images deteriorates slightly.
- The top and bottom of the Multi pictures will be cut off slightly.

#### Picture-in-Picture Mode

- If Mode Dial is operated, the smaller picture disappears.
- Titles cannot be inserted into the smaller picture.

#### Wipe Mode and Mix Mode

If one of the following operations are carried out, stored images will be erased, and Wipe and Mix Functions cannot be used.

- Set another Digital Effect item
- Operate the [OFF/ON] switch or Mode Dial
- Insert or eject a cassette

### ■ Playing Back

#### Repeat Playback

If you continue to press the [▶] Button for 5 seconds or longer, the Camcorder switches to Repeat Playback Mode, and the [R ▷] Indication appears. (To cancel Repeat Playback Mode, set the [OFF/ON] Switch to [OFF].)

#### Listening to Playback Sound through Headphones

If you want to use the headphones to listen to the playback sound, set [AV JACK] on the [INITIAL] Sub-Menu to [OUT/PHONES] and connect the headphones to the [PHONES] Jack (p. 13) on the Camcorder. In this case, no sound (including warning and shutter sounds) will be reproduced through the built-in speaker of the Camcorder.

#### Choosing Sound during Playback

You can select the sound by using the [AUDIO OUT] setting on the [PLAYBACK] Sub-Menu.

STEREO: Stereo Sound (main sound and sub sound)

L: Left channel sound (main sound)

R: Right channel sound (sub sound)

- If you dub a tape recorded at the [12bit] selected as the [AUDIO REC] on the [RECORDING] Sub-Menu, playback sound becomes stereo sound regardless of the [AUDIO OUT] setting if [12bit AUDIO] is set to [MIX].

### ■ Index Search Functions

- Index Search may not be possible at the beginning of the tape.
- Scene Index Search may not function properly if the interval between 2 scene index signals is less than 1 minute.

### ■ Playback Zoom Function

- You cannot adjust the sound volume with the Remote Control in Playback Zoom Mode.
- If you turn off the Camcorder power or if you operate the Mode Dial, Playback Zoom Mode is automatically canceled.
- Even if Playback Zoom Functions are being used, images that are output from the DV Terminal (p. 13) are not enlarged.
- As you enlarge an image, the quality of the image deteriorates.
- During a Playback Zoom, the Variable Speed Search Function cannot be changed with the Remote Control.

### ■ Playback Digital Effect Functions

- Signals of images to which digital effects are added during playback cannot be output from the DV Terminal (p. 13).
- You cannot use the Wipe or Mix Function while playing back the non-recorded portion of tape.

### ■ Playing Back a Card

- If a blank (nothing recorded) Card is played, the screen becomes white.
- If you attempt to play back a file recorded in a different format or if file data is defective, the whole display becomes bluish and the [UNPLAYABLE CARD] Indication may appear as warning.
- When playing back a picture recorded on other equipment, its size and that of this Camcorder may appear differently.
- When playing back a picture recorded on other equipment, the picture may not be played back or the quality of pictures may be deteriorated.
- When playing back a non standardized file, the Folder File Number may not be displayed.
- In the following cases, black bars may appear, depending on the playback device.
  - When playing back a mega-pixel still-picture with this Camcorder and recording it onto a tape
  - Changing the picture size to 640 x 480 pixels with DV STUDIO

### ■ Slide Show

- Playback time may take longer than usual depending on the picture.



### ■ Creating a Title

- Even if the contrast of the Title is adjusted, the portions where there is little difference between light and dark and where the boundary between light and dark is unclear may not appear.
- The Title may not be clear if something small is used for it.
- If titles are created, the number of images that can be recorded on a Card decreases.
- If the number of images that can be recorded on a Card is small, you may not be able to create a title.

### ■ Adding a Title

- The Title In Function and Digital Effects cannot be used simultaneously.
- The Title In Function and RapidFire Consecutive Photoshot cannot be used simultaneously.
- When a title is displayed in Tape Playback Mode, the title is not output from the DV Terminal.
- The Multi-Picture Mode cannot be used once the title is inserted.
- A full-colored title made on other equipment cannot be played back or added to the picture with this Camcorder.
- A title with a size than 640 x 480 pixels cannot be displayed.
- When the title is displayed on the Multi screen, the recording and the playback cannot be performed.
- During DV input, you cannot use Title In Function or display titles on the Multi screen. Select the desired titles to display them on the screen before connecting the DV cable to the Camcorder.

### ■ DPOF

- Perform the DPOF Settings with your Camcorder.
- Verifying the DPOF Settings may take a little time. Wait until the Card Access Lamp goes out.

### ■ Lock Setting

- The Lock Setting carried out by this Camcorder is only effective for this Camcorder.
- The SD Memory Card has a write protection switch on it. If the switch is moved to the [LOCK] side, you cannot write to or format the Card. If it is moved back, you can.

### ■ Playing Back on Your TV

- Depending on your TV, nothing may be shown even if you correctly connect the Camcorder with your TV. In this case, set [AV JACK] on the [INITIAL] Sub-Menu to [OUT].
- Picture size may be displayed differently when playing back a Cinema picture on a wide-screen TV with Playback Digital Effect.

### ■ Recording Pictures from a Card onto a Tape

- When recording the Card Image on a Tape, its size is transformed into 720 x 480 pixels according to the DV format.
- If you attempt to record a still picture with a large image size on a Tape, there may be a reduction in the quality of the image.

### ■ Audio Dubbing

- The blank section of a tape cannot be dubbed.
- Sounds sent through the DV terminal cannot be dubbed.
- If a tape has a non-recorded portion when the tape is dubbed, images and sounds may be disturbed when this portion of the tape is played back.
- If you set the tape counter back to 0 at the position where you want to stop Audio Dubbing so as to make it possible to use the Memory Stop Function (p. 71), Audio Dubbing is terminated automatically when the tape reaches this position.
- In the case of importing data recorded with Audio Dubbing to a PC using the PC's software, only the original sound (ST1) may be imported, depending on the software.

### ■ Using the DV Cable for Recording (Digital Dubbing)

- Regardless of the setting, digital dubbing is carried out automatically in the same audio recording mode as that of the playback Cassette.
- The images on the recorded monitor may be disturbed, but it does not affect the recorded images.
- Even if Playback Digital Effects, Playback Zoom, or Playback Title In have been used, these effects are not output from the DV terminal.
- Even if you use a device equipped with DV Terminals, you may not be able to perform Digital Dubbing in some cases.
- Date or other information to be displayed cannot be displayed if the software of the connected equipment does not support the display function.

### *Cautions for Use*

#### ■ After Use

- 1 Take out the Cassette. (p. 17)
- 2 Set the [OFF/ON] Switch to [OFF].
- 3 Take out the Card. (p. 18)
- 4 Detach the power supply and retract the Viewfinder or the LCD Monitor. (pp. 15-16, 19)
- 5 To protect the Lens, attach the supplied Lens Cap.

## ■ Cautions for Use

**When you use your Camcorder on a rainy or snowy day or on a beach, make sure that no water enters the Camcorder.**

- Water may cause the Camcorder or Cassette to malfunction. (Irreparable failure may occur.)
- If sea water splashes onto the Camcorder, wet a soft cloth with tap water, wring it well, and use it to wipe the camera body carefully. Then, wipe it again thoroughly with a soft dry cloth.

**Keep the Camcorder away from magnetized equipment (such as a microwave oven, TV, video game equipment, etc.).**

- If you use the Camcorder on or near a TV, images or sounds may be disturbed due to electromagnetic wave radiation.
- Do not use near a cell phone because doing so may cause noise to adversely affect the picture and sound.
- Recordings on the tape may be damaged, or images may be distorted, by strong magnetic fields created by speakers or large motors.
- Electromagnetic wave radiation generated by a microprocessor may adversely affect the Camcorder, causing the disturbance of images and sounds.
- If the Camcorder is affected by magnetically charged equipment and does not function properly, turn off the Camcorder power and detach the Battery or AC Adaptor and then connect the Battery or AC Adaptor again. Thereafter, turn on the Camcorder power.

**Do not use your Camcorder near radio transmitters or high-voltage cables.**

- If you record pictures near radio transmitters or high-voltage cables, recorded images or sounds may be adversely affected.

**Do not use this Camcorder for surveillance purposes or other business use.**

- If you use the Camcorder for a long period of time, the internal temperature increases and, consequently, this may cause malfunction.
- This Camcorder is not intended for business use.

**When you use your Camcorder on a beach or similar place, do not let sand or fine dust get into the Camcorder.**

- Sand or dust may damage the Camcorder or Cassette. (Care should be taken when inserting and removing the Cassette.)

**Do not spray insecticides or volatile chemicals onto the Camcorder.**

- If the Camcorder is sprayed with such chemicals, the camera body may be deformed and the surface finish may peel off.
- Do not keep rubber or plastic products in contact with the Camcorder for a long period of time.

**Do not use benzine, thinner or alcohol for cleaning the Camcorder.**

- The Camcorder body may be deformed and the surface finish may peel off.
- Before cleaning, detach the Battery or pull out the AC Cable from the AC Jack.
- Wipe the Camcorder with a soft dry cloth. To remove stubborn stains, wipe with a cloth that is soaked in a detergent diluted with water and afterwards finish wiping with a dry cloth.
- For storing or transporting the Camcorder, place it in a bag or case lined with soft pads so as to prevent the coating on the camera body from being worn.

**After use, be sure to take the Cassette out and detach the Battery from the Camcorder or pull out the AC Cable from AC Jack.**

- If the Cassette is left in the Camcorder, the tape sags and deteriorates.
- If the Battery is left on the Camcorder for a long time, the voltage drops excessively, and the Battery will not function even after it is recharged.

## ■ About AC Adaptor

- If the temperature of the Battery is extremely high or extremely low, the [CHARGE] Lamp may continue flashing, and the Battery may not be charged. After the temperature of the Battery has decreased or increased sufficiently, charging starts automatically. If the [CHARGE] Lamp continues to flash even after the Battery temperature has decreased or increased sufficiently, the Battery or AC Adaptor may be faulty. In this case, please contact a dealer.
- If the Battery is warm, charging takes a longer time than normal.
- If you use the AC Adaptor near a radio, radio reception may be disturbed. Keep the AC Adaptor 3 feet (1 meter) or more away from radio.
- When using the AC Adaptor, it may generate whirring sounds. However, this is normal.
- After use, be sure to pull out the AC Cable from the AC Jack. (If they are left connected, a minute amount of current is consumed.)
- Keep the electrodes of the AC Adaptor and Battery always clean.

## ■ Condensation

If you turn the Camcorder on when condensation occurs on the head or the tape, Condensation Indication [  DEW ] (yellow or red) blinks on the Viewfinder or the LCD Monitor and the messages [DEW DETECTED] or [EJECT TAPE] (only when the tape is inserted) appear. In this case, follow the procedure below.

### **Blinking in yellow:**

Dew is slightly adhering to the head or the tape.

### **Blinking in red:**

Dew has adhered to the head or the tape.

**1 Remove the tape if it is inserted.**

- It takes about 20 seconds to open the Cassette Holder. This is not a malfunction.

**2 Leave the Camcorder with the Cassette Compartment Cover closed to cool or warm it to the ambient temperature.****When [  DEW ] blinks in yellow**

- You cannot use the Tape Recording/Playback Mode. Leave the Camcorder for about 30 minutes.
- However, you can use the Card Recording Mode or Picture Playback Mode when the cassette is not inserted.

**When [  DEW ] blinks in red**

- The Power Indicator Lamp blinks for about 1 minute and then the Camcorder automatically turns off. Leave it for about 2 to 3 hours.

**3 Turn the Camcorder on again, set it to the Tape Recording/Playback Mode and then check if the condensation indication disappears.**

Especially in cold conditions, dew may be frozen. In this case, it may take more time before the condensation indication disappears.

**Watch for Condensation even before the Condensation Indication is displayed.**

- The condensation indication may not appear depending on circumstances. When condensation occurs on the lens or the Camcorder, it also may occur on the head and the tape. Do not open the Cassette Compartment Cover.

**When the Lens Is Fogged:**

Set the [OFF/ON] Switch to [OFF] and leave the Camcorder in this condition for about 1 hour. When the lens temperature becomes close to the ambient temperature, the fog disappears naturally.

**■ Video Head Clogging and Care**

If the heads (the parts that make contact with the tape) are dirty, mosaic-pattern noise may appear on the playback image, or the screen as a whole becomes black. If the heads are extremely dirty, recording performance deteriorates, and, in the worst case, the Camcorder cannot record at all.

**Causes of Dirty Heads**

- Large quantity of dust in the air
- High-temperature and high-humidity environment
- Damaged tape
- Long operating hours

**Using Panasonic cleaning cassette (AY-DVMCLA)**

- 1 Insert the Head Cleaner into the Camcorder in the same manner as a Video Cassette.**
- 2 Press the [▶] Button, and approximately 20 seconds later, press the [■] Button. (Do not rewind the tape.)**
- 3 Take out the Head Cleaner. Insert a Video Cassette and start recording. Then, play the tape back to check the recorded image.**

**4 If the image is not still clear, repeat Steps 1 to 3. (Do not use the Head Cleaner 3 times or more consecutively.)****Notes:**

- Do not rewind every time you use the Head Cleaner. Rewind only when the tape reaches the end, and then use it again from the beginning in the same manner as before.
- If the heads become dirty soon after cleaning, the tape may be damaged. In this case, immediately stop using that Cassette.
- Do not clean the heads excessively. (Excessive cleaning may cause excessive wear of the heads. If the heads are worn, images cannot be played back even after the heads are cleaned.)
- If the dirty heads cannot be cleaned with the Head Cleaner, the Camcorder needs to be cleaned at a Servicenter. Please consult a dealer.
- Head cleaning due to dirty heads is not considered a malfunction of the product. It is not covered by the warranty.

**Periodical Check-up**

To maintain the highest image quality, we recommend replacement of worn parts, such as heads, etc., after approximately 1000 hours of use. (This, however, depends on operating conditions, such as temperature, humidity, dust, etc.)

**■ Optimal Use of the Battery****Battery Characteristics**

This Battery is a rechargeable lithium ion battery. Its ability to generate power is based upon the chemical reaction that takes place inside it. This reaction is susceptible to the surrounding temperature and humidity, and, if the temperature is too high or too low, the operating time of the Battery becomes shorter. If the Battery is used in an extremely cold environment, the Battery may operate only for about 5 minutes. If the Battery becomes extremely hot, a protective function may operate, and the Battery may become unusable for a while.

**Be Sure to Detach the Battery after Use**

Be sure to detach the Battery from the Camcorder. (If it is left attached to the Camcorder, a minute amount of current is consumed even when the Camcorder power is off.) If the Battery is left attached to the Camcorder for a long time, over-discharge takes place. The Battery may become unusable after it is charged.

**Disposing of an Unusable Battery**

- The Battery has a limited life.
- Do not throw the Battery into fire because it may cause an explosion.

**Always Keep the Terminals of the Battery Clean**

Prevent the terminals from getting clogged with dirt, dust, or other substances. If you drop the Battery accidentally, check to see if the Battery body and terminals are deformed. Attaching a deformed Battery to the Camcorder or AC Adaptor may damage the Camcorder or AC Adaptor.

## ■ Cautions for Storage

### Before storing the Camcorder, take the Cassette out and detach the Battery.

Store all the components in a dry place with a relatively stable temperature.

(Recommended Temperature: 59 °F to 77 °F (15 °C to 25 °C), Recommended Humidity: 40 % to 60 %)

#### Camcorder

- Wrap it with a soft cloth to prevent dust from getting into the Camera.
- Do not leave the Camcorder in places that expose it to high temperature.

#### Battery

- Extremely high temperatures or low temperatures will shorten the life of the Battery.
- If the Battery is kept in smoky or dusty places, the terminals may rust and cause malfunctions.
- **Do not allow the Battery terminals to come in contact with metal objects (such as necklaces, hairpins, etc.). This can result in a short circuit or heat generation and, if you touch the Battery in this condition, you may be badly burned.**
- Store the Battery in a completely discharged state. To store the Battery for a long period of time, we recommend you charge it once every year and store it again after you completely use up the charged capacity.

#### Cassette

- Before storing it, rewind the tape to the beginning. If the Cassette is left for more than 6 months with the tape stopped midway, the tape sags (although it depends on the storage condition). Be sure to rewind to the beginning.
- Store the Cassette in its case. Dust, direct sunlight (ultraviolet rays), or humidity may damage the tape. Dust contains hard mineral particles, and dusty Cassettes damage the heads of the Camcorder and other components. Develop a habit of returning the Cassette back to its case.
- Once every half year, wind the tape to the end and then rewind it to the beginning. If the Cassette is left for 1 year or longer without winding or rewinding, temperature and humidity changes may cause the Cassette to deform due to swelling, shrinking, and so forth. The wound tape may stick to itself.
- Do not place a Cassette near highly magnetic substances or equipment.
- The surface of tape is covered with extremely minute magnetic particles, upon which signals are recorded. Magnetic necklaces, toys, etc., have magnetic force that is stronger than you may normally expect, and they may erase the contents of a recording or may cause noise in images and sounds.

## Card

- When the Card is being read, do not remove the Card, turn off the power, or subject it to vibration or impact.
- Do not leave the Card in places where there is high temperature or direct sunlight, or where electromagnetic waves or static electricity are easily generated.
- Do not bend or drop the Card. The Card or the recorded content may be damaged.
- After use, be sure to remove the Card from the Camcorder.
- After usage, store the supplied SD Memory Card in the enclosed bag.
- Do not touch the terminals on the back of the Card with your fingers. Do not allow dirt, dust or water to enter it.
- Keep the Memory Card out of reach of children to prevent swallowing.

## ■ LCD Monitor/Viewfinder/Lens Hood

### LCD Monitor

- In a place with drastic temperature changes, condensation may form on the LCD Monitor. Wipe it with a soft dry cloth.
- If your Camcorder is extremely cold when you turn its power on, the image on the LCD Monitor is slightly darker than usual at first. However, as the internal temperature increases, it goes back to the normal brightness.

Extremely high precision technology is employed to produce the LCD Monitor screen featuring a total of approximately 105,000 pixels. The result is more than 99.99 % effective pixels with a mere 0.01 % of the pixels inactive or always lit. However, this is not a malfunction and does not affect the recorded picture.

### Viewfinder

- Do not direct the Viewfinder or Lens to the sun. Internal components may be seriously damaged.
- When the Camcorder is used with a large capacity Battery (CGR-D16A/1B, CGP-D28A/1B: Optional) attached to it, it is not practical to look in the Viewfinder from behind the Battery.

Extremely high precision technology is employed to produce the Viewfinder screen featuring a total of approximately 67,000 pixels (PV-GS9/PV-GS12)/ 113,000 pixels (PV-GS14/PV-GS15). The result is more than 99.99 % effective pixels with a mere 0.01 % of the pixels inactive or always lit. However, this is not a malfunction and does not affect the recorded picture.

**Lens Hood**

- Do not attach other conversion lenses in front of the Lens Hood; there is no mount to be used for the attachment.
- When you wish to attach the Tele Conversion Lens (not supplied), Wide Conversion Lens (not supplied), MC Protector (not supplied), or ND Filter (not supplied), first of all, turn the Lens Hood counter-clockwise. If the MC Protector or ND Filter is used, the Lens Hood can be mounted on the filter.
- If you push the [W/T] Lever toward [W] during recording with the filter and conversion lens attached together to the Camcorder, 4 corners of the image may become dark (vignetting). For details, please refer to the operating instructions of your accessories.
- Be sure to keep the Lens Hood attached to the Camcorder so as to shut out unnecessary light.

**Before Requesting Service (Problems and Solutions)**

<b>Power</b>	<p><b>The Camcorder power cannot be turned on.</b></p> <ul style="list-style-type: none"> <li>• Is the power source connected correctly? (pp. 15-16)</li> </ul>
	<p><b>The Camcorder power is turned off automatically.</b></p> <ul style="list-style-type: none"> <li>• When the Recording Pause Mode continues for more than 5 minutes, the power is turned off automatically for tape protection and power conservation. (If the AC Adaptor is used, the power is turned off only when the tape is inserted in Tape Recording Mode.) When the tape is inserted in Tape Recording Mode and if the Recording Pause Mode continues for more than 5 minutes the power is turned off automatically. To resume recording from this condition, turn off, then turn on the power again. (pp. 24-25)</li> </ul>
	<p><b>The Camcorder power does not stay on long enough.</b></p> <ul style="list-style-type: none"> <li>• Is the Battery low? Charge the Battery or attach a fully charged Battery. (p. 15)</li> <li>• Has condensation occurred? Wait until the Condensation Indication disappears. (pp. 66-67)</li> </ul>
<b>Battery</b>	<p><b>Battery runs down quickly.</b></p> <ul style="list-style-type: none"> <li>• Is the Battery fully charged? Charge it with the AC Adaptor. (p. 15)</li> <li>• Are you using the Battery in an extremely cold place? In cold places, the operating time of the Battery becomes shorter. (p. 68)</li> <li>• Has the Battery worn out? If the operating time is still too short even after the Battery is fully charged, the Battery has worn out.</li> </ul>
	<p><b>The Battery cannot be charged.</b></p> <ul style="list-style-type: none"> <li>• If the DC Cable is connected to the AC Adaptor, charging cannot be performed. Disconnect the DC Cable.</li> </ul>

<b>Normal Recording</b>	<p><b>Recording does not start although power is supplied to the Camcorder and the Cassette is correctly inserted.</b></p> <ul style="list-style-type: none"> <li>• Is the accidental erasure prevention slider on the Cassette open? If it is open (set to [SAVE]), recording cannot be performed. (p. 17)</li> <li>• Is the tape wound to the end? Insert a new Cassette. (p. 17)</li> <li>• Is the Camcorder power turned on? (p. 24)</li> <li>• Has condensation occurred? Wait until the Condensation Indication disappears. (pp. 66-67)</li> </ul>
<b>Other Recording</b>	<p><b>Auto Focus Function does not work.</b></p> <ul style="list-style-type: none"> <li>• Is Manual Focus Mode selected? If Auto Focus Mode is selected, focus is automatically adjusted. (pp. 32, 71)</li> <li>• There are some recording subjects and recording surroundings for which the Auto Focus Function does not operate correctly. In this case, use the Manual Focus Mode to adjust the focus. (p. 32)</li> </ul>
<b>Editing</b>	<p><b>Audio dubbing cannot be performed.</b></p> <ul style="list-style-type: none"> <li>• Is the accidental erasure prevention slider on the Cassette open? If it is open (set to [SAVE]), recording cannot be performed. (p. 17)</li> <li>• Are you attempting to edit a tape portion that was recorded in LP Mode? LP Mode does not allow audio dubbing to operate. (p. 23)</li> </ul>
<b>Indications</b>	<p><b>The Time Code becomes inaccurate.</b></p> <ul style="list-style-type: none"> <li>• The Time Code Indication counter may not be constant in the reverse direction in Slow Motion Playback Mode, but this is not a malfunction.</li> </ul>
	<p><b>The Remaining Tape Time Indication does not match the actual remaining tape time.</b></p> <ul style="list-style-type: none"> <li>• If scenes of less than 15 seconds are continuously recorded, the remaining tape time cannot be displayed correctly.</li> <li>• In some cases, the Remaining Tape Time Indication may show remaining tape time that is 2 to 3 minutes shorter than the actual remaining tape time.</li> </ul>
<b>Playback (Pictures)</b>	<p><b>Pictures cannot be played back even when the [▶] Button is pressed.</b></p> <ul style="list-style-type: none"> <li>• Is the Mode Dial set to Tape Playback Mode? If not, the playback function cannot be used. (p. 35)</li> </ul>
<b>Playback (Pictures)</b>	<p><b>Mosaic-pattern noise appears on images during Cue, Review or Slow Motion Playback.</b></p> <ul style="list-style-type: none"> <li>• This phenomenon is characteristic of digital video systems. It is not a malfunction.</li> </ul>

Playback (Pictures)	<p><b>Although the Camcorder is correctly connected to a TV, playback images cannot be seen.</b></p> <ul style="list-style-type: none"> <li>Have you selected "Video Input" on the TV? Please read the operating instructions of your TV and select the channel that matches the input jacks used for the connection.</li> <li>Depending on your TV, nothing may be shown even if you correctly connect the Camcorder with your TV. In this case, set [AV JACK] on the [INITIAL] Sub-Menu to [OUT].</li> </ul>	Card	<p><b>Recorded pictures are not clear.</b></p> <ul style="list-style-type: none"> <li>Is [PICT QUALITY] on the [CARD] Sub-Menu set to [NORMAL] or [ECONOMY]? If recording is done with it set to [NORMAL] or [ECONOMY], images with fine details may include a mosaic-like pattern. Set [PICT QUALITY] to [FINE]. (p. 25)</li> </ul>
	<p><b>Playback picture is not clear.</b></p> <ul style="list-style-type: none"> <li>Are the heads of the Camcorder dirty? If the heads are dirty, playback image cannot be clear. (p. 67)</li> </ul>		<p><b>Photoshot Playback images do not look normal.</b></p> <ul style="list-style-type: none"> <li>The picture may be damaged. In order to prevent the loss of image data, backing up on a Cassette or a personal computer is recommended. (pp. 44, 48)</li> </ul>
	<p><b>Playing back or recording do not function, the screen has frozen or the indication has disappeared.</b></p> <ul style="list-style-type: none"> <li>Turn the Camcorder off. If the Camcorder is not turned off after operating the [OFF/ON] switch, press the [RESET] Button (p. 12) first. And detach the Battery or AC Adaptor and then reattach it.</li> </ul>		<p><b>During Playback the [UNPLAYABLE CARD] Indication is displayed.</b></p> <ul style="list-style-type: none"> <li>The image was either recorded in a different format, or data is damaged.</li> </ul>
Playback (Sound)	<p><b>Sound is not played back from the built-in speaker of the Camcorder or the headphones.</b></p> <ul style="list-style-type: none"> <li>Is the volume too low? During playback, push the [W/T] Lever to display the [VOLUME] Indication and adjust the volume. (p. 35)</li> </ul>	Others	<p><b>Even if a Card is formatted, it cannot be used.</b></p> <ul style="list-style-type: none"> <li>Either the Camcorder or the Card may be damaged. Please consult a dealer.</li> </ul>
	<p><b>Different sounds are reproduced at the same time.</b></p> <ul style="list-style-type: none"> <li>[12bit AUDIO] on the [PLAYBACK] Sub-Menu of the [TAPE PLAYBACK MENU] has been set to [MIX]. As a result, the original sound and sound that was recorded by audio dubbing are played back together. It is possible to reproduce the sounds separately. (p. 44)</li> </ul>		<p><b>The Camcorder clatters when shaking it.</b></p> <ul style="list-style-type: none"> <li>It is a sound of the lens moving, not a malfunction.</li> </ul>
	<p><b>The original sound was erased when audio dubbing was performed.</b></p> <ul style="list-style-type: none"> <li>If you perform audio dubbing on a recording made in [16bit] Mode, the original sound will be erased. If you wish to preserve the original sound, be sure to select [12bit] Mode at the time of recording.</li> </ul>		<p><b>When the USB Cable is disconnected, an error message will appear on PC.</b></p> <ul style="list-style-type: none"> <li>To disconnect the USB cable safely, double-click the [  ] icon in the task tray and follow the instructions on the screen. (p. 49)</li> </ul>

### Using the RESET button

- 1 Open the LCD Monitor. (p. 19)
- 2 Undo Grip Belt end ① and pull Lens Cap Cord ② downward to loosen Grip Belt.

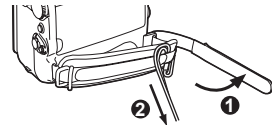

- 3 Use projection ③ on the Lens Cap to press the [RESET] Button ④.

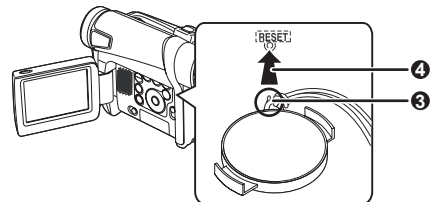

## Explanation of Terms

### ■ Digital Video System

In a digital video system, images and sounds are converted into digital signals and recorded on a tape. This complete digital recording is capable of recording and playback with minimal image and sound deterioration.

In addition, it automatically records data, such as Time Code and Date/Time, as digital signals.

### ■ Compatibility with S-VHS or VHS Cassettes

Because this Camcorder employs a digital system for recording image and sound data, it is not compatible with conventional S-VHS or VHS video equipment that employs an analog recording system.

The size and shape of the Cassettes are also different.

### ■ Compatibility with Output Signals

Because AV signal output from the AV signal output Jack is analog (the same as conventional video systems), this Camcorder can be connected with S-VHS or VHS video or a TV for playback.

### ■ Focus

#### Auto Focus Adjustment

The Auto Focus System automatically moves forward and backward the focusing lens inside the Camcorder to bring the subject into focus so that the subject can be seen clearly.

However, the Auto Focus System does not function properly for the following subjects or under the following recording conditions.

**Please use the Manual Focus Mode instead.**

#### 1) Recording a subject whose one end is located closer to the Camcorder and the other end farther away from it

- Because Auto Focus makes adjustments at the center of an image, it may be impossible to focus on a subject that is located in both foreground and background.

#### 2) Recording a subject behind dirty or dusty glass

- Because the focus is on the dirty glass, the subject behind the glass will not be focused.

#### 3) Recording a subject in dark surroundings

- Because the light information that comes through the lens decreases considerably, the Camcorder cannot focus correctly.

#### 4) Recording a subject that is surrounded by objects with glossy surfaces or by highly reflective objects

- Because the Camcorder focuses on the objects with glossy surfaces or on highly reflective objects, the subject may become blurry.

#### 5) Recording a fast-moving subject

- Because the focus lens-inside moves mechanically, it cannot keep up with the fast-moving subject.

#### 6) Recording a subject with little contrast

- Because the Camcorder achieves focus based upon the vertical lines of an image, a subject with little contrast, such as a white wall, may become blurry.

### ■ Time Code

Time Code signals are data that indicate time measured in hours, minutes, seconds, and frames (30 frames per second). If this data is included in a recording, an address is assigned to each image on the tape.

- The Time Code is automatically recorded as a part of the sub-code at each recording.
- When a new (previously unrecorded) Cassette is inserted, the Time Code automatically starts from zero. If a recorded Cassette is inserted, the Time Code picks up from the point where the last scene was recorded. (In this case, when the Cassette is inserted, the zero display [0h00m00s00f] may appear, but the Time Code starts from the previous value.)
- The Time Code cannot be reset to zero.
- Unless the Time Code is continuously recorded from the beginning of a tape, accurate editing may not be possible. To ensure that the Time Code will be recorded with no breaks, we recommend the use of the Blank Search Function (p. 24) before recording a new scene.

### ■ Memory Stop Function

The Memory Stop Function is useful for the following operations.

**Rewinding or fast-forwarding a tape to a desired position**

1 Set [DISPLAY] >> [C.DISPLAY] >> [MEMORY].

2 Reset the Tape Counter to zero at the tape position from which you want to play it back later. (pp. 14, 21)

3 Start playback or recording.

4 After playback or recording has finished:

**Set the Camcorder to Tape Playback Mode.**

- The [POWER] Lamp lights up.

5 Rewind the tape.

- The tape automatically stops approximately at the position where the counter was set to zero.

**Stopping editing automatically during audio dubbing**

1 Set [DISPLAY] >> [C.DISPLAY] >> [MEMORY].

2 Reset the Tape Counter to zero at the position where you want to stop editing.

3 Play back the still picture where you want to start audio dubbing.

4 Start audio dubbing. (p. 44)

- Audio dubbing automatically stops at the position where the counter was set to zero.

## Specifications

### Digital Camcorder

Information for your safety

#### Power Source:

DC 7.2/7.8 V

#### Power Consumption:

Recording

4.5 W

#### Recording Format:

Mini DV (Consumer-use Digital Video SD Format)

#### Tape Used:

6.35 mm digital video tape

#### Recording/Playback Time:

SP: 80 min.; LP: 120 min. (with DVM80)

#### Video

#### Recording System:

Digital Component

#### Television System:

EIA Standard: 525 lines, 60 fields NTSC color signal

#### Audio

#### Recording System:

PCM Digital Recording

16 bit (48 kHz/2ch), 12 bit (32 kHz/4ch)

#### Image Sensor:

1/6-inch CCD Image Sensor

#### Lens:

Auto Iris, F1.8, Focal Length; 2.1-50.4 mm (PV-GS15) / 2.1-46.2 mm (PV-GS14) / 2.1-42 mm (PV-GS9/PV-GS12), Macro (Full Range AF)

#### Filter Diameter:

27 mm

#### Zoom:

20:1 Power Zoom (PV-GS9/PV-GS12)

22:1 Power Zoom (PV-GS14)

24:1 Power Zoom (PV-GS15)

#### Monitor:

2.5-inch LCD

#### Viewfinder:

Color Electronic Viewfinder (PV-GS14/PV-GS15)

Electronic Viewfinder (PV-GS9/PV-GS12)

#### Microphone:

Stereo

#### Speaker:

1 round speaker 20 mm

#### Standard Illumination:

1,400 lx

#### Minimum Required Illumination:

2 lx (MagicPix Mode)

#### Video Output Level:

1.0 Vp-p, 75 ohm

#### S-Video Output Level: (For PV-GS14/PV-GS15)

Y Output: 1.0 Vp-p, 75 ohm

C Output: 0.286 Vp-p, 75 ohm

#### Audio Output Level (Line):

316 mV, 600 ohm

#### Mic Input: (For PV-GS14/PV-GS15)

Mic sensitivity -50 dB (0 dB=1 V/Pa, 1 kHz)  
(Stereo mini jack)

#### USB:

Card reader/writer function (For PV-GS12/  
PV-GS14/PV-GS15), USB 2.0 compliant  
(max. 12 Mbps)

No copyright protection support

#### Digital Interface:

DV Input/Output Jack (IEEE1394, 4-pin)

#### Dimensions:

Approx. 87 (H) x 69 (W) x 112 (D) mm

Approx. 3-3/8 (H) x 2-3/4 (W) x 4-3/8 (D) inch

#### Weight:

Approx. 0.40 kg (0.88 lbs.) (PV-GS9/PV-GS12)

Approx. 0.41 kg (0.90 lbs.) (PV-GS14/PV-GS15)  
(without Battery and DV cassette)

#### Operating Temperature:

32 °F - 104 °F (0 °C-40 °C)

#### Operating Humidity:

10 % - 80 %

#### Card Memory Functions (For PV-GS12/PV-GS14/ PV-GS15)

#### Recording Media:

MultiMediaCard (4 MB/8 MB/16 MB)

SD Memory Card (8 MB/16 MB/32 MB/64 MB/

128 MB/256 MB/512 MB)

#### Still picture recording file format:

JPEG (Design rule for Camera File system, based  
on Exif 2.2 standard), DPOF corresponding

#### Still Image Size:

640 X 480 pixels (VGA)

#### WEB Camera

#### Compression:

Motion JPEG

#### Image Size:

320 X 240 pixels (QVGA)

#### AC Adaptor

Information for your safety

#### Power Source:

110/120/220/240 V AC, 50/60 Hz

#### Power Consumption:

18 W

#### DC Output:

DC 7.8 V, 1.4 A (Camcorder Operation)

DC 8.4 V, 1.2 A (Battery Charging)

#### Dimensions:

70 (W) X 45 (H) X 115 (D) mm

2-3/4 (W) X 1-3/4 (H) X 4-1/2 (D) inch



#### Weight:

Approx. 0.16 kg (0.35 lbs.)

Weight and dimensions are approximate values.  
Specifications may change without prior notice.



**Camcorder Accessory System**

Accessory #	Figure	Description	Price
PV-DAC11A		AC Adaptor with AC Cable and DC Cable	\$119.95
CGR-D08A/1B		800 mAh/1 h 30 min, Battery Pack	\$69.95
CGR-D16A/1B		1 600 mAh/3 h, Battery Pack	\$99.95
CGP-D28A/1B		2 800 mAh/5 h, Battery Pack	\$129.95
CGR-D53A/1K		5 300 mAh/9 h, Battery Pack	\$229.95
PV-DDC9		DV Interface Cable (i.LINK) (4-pin to 4-pin)	\$55.00
LSSQ0411		IR Remote Control	Call For Pricing
RP-SD64BPPA RP-SD32BPPA RP-SD16BPPA		64 MB SD Memory Card 32 MB SD Memory Card 16 MB SD Memory Card	Call For Pricing
BN-SDCAPE/1B		USB Reader/Writer for SD Memory Card (compatible with MultiMediaCard)	\$79.95
BN-SDABPE/1B		SD PCMCIA Adaptor (compatible with MultiMediaCard)	\$79.95
LSFT0577		DV STUDIO 3.1E-SE	Call For Pricing
K1HA05CD0005		USB Cable	Call For Pricing
PV-H150		Carrying Case	\$49.95
PV-HB002		Carrying Case	Call For Pricing

• Please refer to page 74, when placing an order.

## Camcorder Accessory Order Form

Please photocopy this form when placing an order.

1. Camcorder Model # \_\_\_\_\_  
 2. Items Ordered \_\_\_\_\_

Accessory #	Description	Price Each	Quantity	Total Price
Subtotal				
Your State & Local Sales Tax				
Shipping & Handling				6.95
Total Enclosed				

3. Method of payment (check one)

- Check of Money Order enclosed (NO C.O.D.SHIPMENTS)  
 VISA                      Credit Card # \_\_\_\_\_  
 MasterCard              Expiration Date \_\_\_\_\_  
 Discover                    Customer Signature \_\_\_\_\_

Make Check or Money Order to: PANASONIC ACCESSORIES

(Please do not send cash)

4. Shipping information (UPS delivery requires complete street address)

Ship To:

Mr.  
Mrs.  
Ms.

\_\_\_\_\_

First

Last

Phone #:

Day ( ) \_\_\_\_\_

\_\_\_\_\_

Street Address

Night ( ) \_\_\_\_\_

\_\_\_\_\_

City

\_\_\_\_\_

State

\_\_\_\_\_

Zip

TO OBTAIN ANY OF OUR CAMCORDER ACCESSORIES YOU CAN DO ANY OF THE  
 FOLLOWING:

VISIT YOUR LOCAL PANASONIC DEALER

OR

CALL PANASONIC'S ACCESSORY ORDER LINE AT 1-800-332-5368

[6 AM-5 PM M-F, 6 AM-10:30 AM SAT, PACIFIC TIME]

OR

MAIL THIS ORDER TO: PANASONIC SERVICES COMPANY ACCESSORY ORDER OFFICE

20421 84th Avenue South Kent, WA. 98032

***Request for Service Notice***

---

Please photocopy this form when making a request for service notice.

**Request for Service Notice:**

In the unlikely event this product needs service.

- Please include your **proof of purchase**.  
(Failure to do so will delay your repair.)
- To further speed your repair, please provide an explanation of what is wrong with the unit and any symptom it is exhibiting.

---

---

---

---

Mail this completed form and your Proof of Purchase along with your unit to:  
Panasonic Services Company  
1705 N. Randall Road  
Elgin, IL. 60123-7847  
Attn: Camcorder Repair

## Limited Warranty

PANASONIC CONSUMER ELECTRONICS COMPANY,  
DIVISION OF MATSUSHITA ELECTRIC CORPORATION  
OF AMERICA  
One Panasonic Way Secaucus, New Jersey 07094

PANASONIC SALES COMPANY, DIVISION OF  
MATSUSHITA ELECTRIC OF PUERTO RICO, INC.,  
AVE. 65 de Infantería, Km. 9.5 San Gabriel Industrial Park,  
Carolina, Puerto Rico 00985

## Panasonic/Quasar Video Products Limited Warranty

### Limited Warranty Coverage

If your product does not work properly because of a defect in materials or workmanship, Panasonic Consumer Electronics Company or Panasonic Sales Company (collectively referred to as "the warrantor") will, for the length of the period indicated on the chart below, which starts with the date of original purchase ("warranty period"), at its option either (a) repair your product with new or refurbished parts, or (b) replace it with a new or a refurbished product. The decision to repair or replace will be made by the warrantor.

Product	Parts	Labor	Service	Contact Number
Camcorder	One (1) Year (except CCD Image Sensor)	Ninety (90) Days	Carry-In or Mail-In	1-800-211-PANA(7262)
	CCD Image Sensor - 6 (Six) Months	Ninety (90) Days		
DVD/VCR Deck, A/V Mixer	One (1) Year	Ninety (90) Days	Carry-In or Mail-In	1-800-211-PANA(7262)
TV/VCR, TV/DVD, TV/DVD/VCR Combination	One (1) Year (except CRT) CRT - Two (2) Years	Ninety (90) Days Ninety (90) Days	Carry-In: 21" CRT and Smaller In-Home or Carry-In: 22" CRT and Larger	1-800-211-PANA(7262)
TV/HDR Combination	One (1) Year (except CRT) CRT - Two (2) Years	Ninety (90) Days Ninety (90) Days	In-Home or Carry-In	1-888-843-9788
Rechargeable Batteries (in exchange for defective item)	Ten (10) Days	Not Applicable	Carry-In or Mail-In	1-800-211-PANA(7262)
Tape (in exchange for defective item)	Five (5) Days	Not Applicable	Carry-In or Mail-In	1-800-211-PANA(7262)
Memory Cards (in exchange for defective item)	Ninety (90) Days	Not Applicable	Carry-In or Mail-In	1-800-211-PANA(7262)

During the "Labor" warranty period there will be no charge for labor. During the "Parts" warranty period, there will be no charge for parts. You must carry-in or mail-in your product or arrange for in-home service, as applicable, during the warranty period. If non-rechargeable batteries are included, they are not warranted. This warranty only applies to products purchased and serviced in the United States or Puerto Rico. This warranty is extended only to the original purchaser of a new product which was not sold "as is". A purchase receipt or other proof of the original purchase date is required for warranty service.

### Carry-In, Mail-in or In-Home Service

For Carry-In, Mail-In or In-Home Service (as applicable) in the United States call toll free contact number listed above or visit Panasonic Web Site: <http://www.panasonic.com>

For assistance in Puerto Rico call Panasonic Sales Company (787)-750-4300 or fax (787)-768-2910.

In-Home service, if applicable, requires clear, complete and easy access to the product by the authorized servicer and does not include removal or re-installation of an installed product. It is possible that certain in-home repairs will not be completed in-home, but will require that the product, or parts of the product, be removed for shop diagnosis and/or repair and then returned.

**Limited Warranty Limits And Exclusions**

This warranty ONLY COVERS failures due to defects in materials or workmanship, and DOES NOT COVER normal wear and tear or cosmetic damage, nor does it cover markings or retained images on the picture tube resulting from viewing fixed images (including, among other things, letterbox pictures on standard 4:3 screen TV's, or non-expanded standard 4:3 pictures on wide screen TV's, or onscreen data in a stationary and fixed location). The warranty ALSO DOES NOT COVER damages which occurred in shipment, or failures which are caused by products not supplied by the warrantor, or failures which result from accidents, misuse, abuse, neglect, mishandling, misapplication, alteration, faulty installation, set-up adjustments, misadjustment of consumer controls, improper maintenance, power line surge, lightning damage, modification, or commercial use (such as in a hotel, office, restaurant, or other business), rental use of the product, service by anyone other than a Factory Servicenter or other Authorized Servicer, or damage that is attributable to acts of God.

**THERE ARE NO EXPRESS WARRANTIES EXCEPT AS LISTED UNDER "LIMITED WARRANTY COVERAGE". THE WARRANTOR IS NOT LIABLE FOR INCIDENTAL OR CONSEQUENTIAL DAMAGES RESULTING FROM THE USE OF THIS PRODUCT, OR ARISING OUT OF ANY BREACH OF THIS WARRANTY.** (As examples, this excludes damages for lost time, cost of having someone remove or re-install an installed unit if applicable, or travel to and from the servicer, loss of media or images, data or other memory or recorded content. The items listed are not exclusive, but are for illustration only.)

**ALL EXPRESS AND IMPLIED WARRANTIES, INCLUDING THE WARRANTY OF MERCHANTABILITY, ARE LIMITED TO THE PERIOD OF THE LIMITED WARRANTY.**

Some states do not allow the exclusion or limitation of incidental or consequential damages, or limitations on how long an implied warranty lasts, so the exclusions may not apply to you.

This warranty gives you specific legal rights and you may also have other rights which vary from state to state. If a problem with this product develops during or after the warranty period, you may contact your dealer or Servicenter. If the problem is not handled to your satisfaction, then write to the warrantor's Consumer Affairs Department at the addresses listed for the warrantor.

**PARTS AND SERVICE (INCLUDING COST OF AN IN-HOME SERVICE CALL, WHERE APPLICABLE) WHICH ARE NOT COVERED BY THIS LIMITED WARRANTY ARE YOUR RESPONSIBILITY.**

## Customer Services Directory

Obtain Product Information and Operating Assistance; locate your nearest Dealer or Servicenter; purchase Parts and Accessories; or make Customer Service and Literature requests by visiting our Web Site at:

<http://www.panasonic.com/support>

or, contact us via the web at:

<http://www.panasonic.com/contactinfo>

You may also contact us directly at:

1-800-211-PANA (7262),

Monday-Friday 9 am-9 pm; Saturday-Sunday 10 am-7 pm, EST.

For hearing or speech impaired TTY users, TTY : 1-877-833-8855

### Accessory Purchases

Purchase Parts, Accessories and Instruction Books online for all Panasonic Products by visiting our Web Site at:

<http://www.pasc.panasonic.com>

or, send your request by E-mail to:

[npcparts@panasonic.com](mailto:npcparts@panasonic.com)

You may also contact us directly at:

1-800-332-5368 (Phone) 1-800-237-9080 (Fax Only) (Monday – Friday 9 am to 8 pm, EST.)

Panasonic Services Company

20421 84th Avenue South,

Kent, WA 98032

(We Accept Visa, MasterCard, Discover Card, American Express, and Personal Checks)

For hearing or speech impaired TTY users, TTY : 1-866-605-1277

### Product Repairs

### Centralized Factory Servicenter

MAIL TO :

Panasonic Services Company

1705 N. Randall Road,

Elgin, IL 60123-7847

Attention: Camcorder Repair

Please carefully pack and ship, prepaid and insured, to the Elgin Centralized Factory Servicenter. Customer's in Puerto Rico, please ship or carry in to location below ("Service in Puerto Rico").

### Service in Puerto Rico

**Matsushita Electric of Puerto Rico, Inc. Panasonic Sales Company**

**Factory Servicenter:**

**Ave. 65 de Infantería, Km. 9.5, San Gabriel Industrial Park,**

**Carolina, Puerto Rico 00985**

**Phone (787)750-4300, Fax (787)768-2910**

As of October 2003

## Spanish Quick Use Guide/Guía Para Uso Rápido





### Precauciones para su seguridad

#### ADVERTENCIA:

**Para evitar incendios y descargas eléctricas, no exponga este equipo a la lluvia ni a la humedad.**

Su <sup>Mini</sup> DV Camcorder está diseñada para grabar y reproducir en el modo de Reproducción Estándar (SP) y modo Largo (LP).

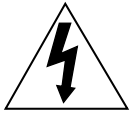
Se recomienda el uso sólo de cintas de cassette que hayan sido probadas e inspeccionadas para su uso en aparatos VCR con la marca <sup>Mini</sup> DV.

 <div style="text-align: center;"> <p><b>PRECAUCIÓN</b> RIESGO DE DESCARGA ELÉCTRICA NO ABRIR</p>  </div>		<p>Este símbolo tiene por finalidad alertar al usuario acerca de la presencia de tensión sin aislación en el interior del producto, que puede tener la intensidad suficiente como para causar descargas eléctricas. Por lo tanto, hacer contacto con cualquier pieza en el interior de la unidad es peligroso.</p>
<p>PRECAUCIÓN: PARA REDUCIR EL RIESGO DE DESCARGA ELÉCTRICA, NO quite la cubierta (o parte posterior), el aparato no tiene en su interior piezas que puedan ser reparadas por el usuario. Solicite toda reparación a personal de servicio cualificado.</p>		<p>Este símbolo tiene por finalidad alertar al usuario de la presencia de importantes instrucciones de operación y mantenimiento en la literatura incluida con la unidad. Por lo tanto, lea detenidamente la literatura incluida para evitar problemas.</p>

**La etiqueta de régimen está pegada en la base de la cubierta del cargador.**

Este dispositivo cumple con la parte 15 de las Reglas del FCC. El funcionamiento está sujeto a las dos siguientes condiciones: (1) Este dispositivo puede no causar interferencias perjudiciales, y (2) este dispositivo debe aceptar cualquier interferencia recibida, incluyendo interferencias que pueden causar un funcionamiento no deseado.

#### Nota:

Este equipo ha sido puesto a prueba y se encontró que cumple con la Parte 15 de las reglas del FCC. Estos límites están diseñados para proveer una protección razonable contra interferencias cuando se opera en un ambiente residencial.

Si este equipo causa interferencias en la recepción de radio o televisión, lo cual se puede comprobar al apagar y encender el equipo, utilice el equipo en otra ubicación y/o utilice un tomacorriente diferente al que está utilizando el receptor.

Si es necesario, consulte con el distribuidor o un técnico experto de radio/TV para solicitar ayuda. Puede encontrar útil el folleto 'Información sobre las interferencias' disponible en las oficinas regionales del FCC local.

#### Advertencia del FCC:

Para asegurar la conformidad continua del FCC, utilice solamente el cable de interfaz blindado cuando conecte una cámara de video digital a una computadora de acuerdo con las instrucciones incluidas aquí. También, cualquier cambio sin autorización o modificaciones a este equipo anularían la autoridad del usuario para operarlo.

## Guía rápida

- 1** Coloque la batería en el adaptador de CA y cárguela.

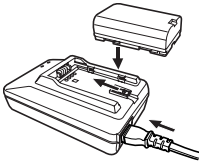

- Antes de usar, cargue completamente la batería.
- Debido a que la batería no se cargará cuando el cable de entrada de CC esté conectado al adaptador de CA, desconéctelo del adaptador de CA.
- La lámpara [CHARGE] se enciende, y comienza la carga.
- Cuando la lámpara [CHARGE] se apaga, se ha terminado la carga.

- 2** Coloque la batería cargada en el Camcorder.

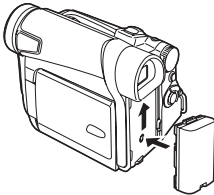

### ■ Inserción de un cassette

- 1** Deslice la palanca [OPEN/EJECT] **1** hacia el frente y tire hacia abajo para abrir la tapa del compartimiento del cassette.

- Para proteger la cinta, el casete no podrá expulsarse, si la tapa no está completamente abierta.

- 2** Inserte un cassette.

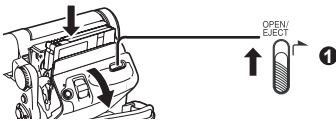

- 3** Cierre el soporte del cassette presionando la marca [PUSH] **2**.

- 4** Cierre la cubierta del compartimiento del cassette presionando la marca **3**.

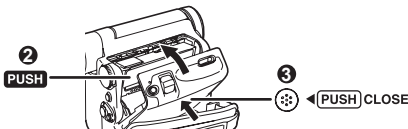

### ■ Inserción de una tarjeta de memoria (Sólo para el modelo PV-GS12/PV-GS14/PV-GS15)

- 1** Usando su pulgar presione la perilla [OPEN ▼] **1** y saque la pantalla LCD **2** en la dirección de la flecha.

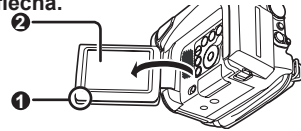

- 2** Deslice la palanca [OPEN] **3** para abrir la cubierta de la ranura de tarjeta **4**.

- 3** Mientras sostiene la tarjeta de memoria con su esquina cortada hacia la derecha **5** insértela en la ranura de tarjeta **6**.

- 4** Cierre bien la cubierta de ranura de tarjeta **4**.

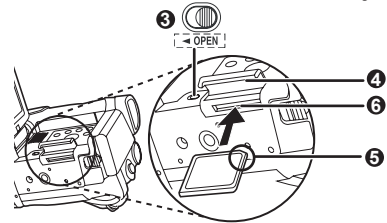

### ■ Grabación de una cinta

- 1** Ajuste el interruptor [OFF/ON] **1** a [ON].

- La lámpara [POWER] **2** se enciende.

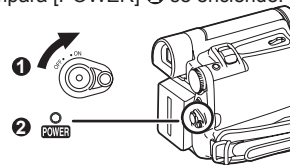

- 2** Gire el dial de modo a modo de grabación de cinta.

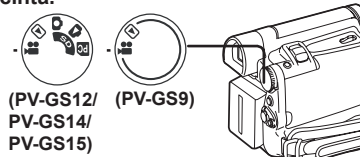

- 3** Presione el botón de inicio/parada de grabación.

- Comienza la grabación.

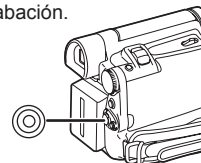

- 4** Presione el botón de inicio/parada de grabación nuevamente para detener la grabación.



■ Grabación de una imagen fija en cinta  
(Sólo para el modelo PV-GS9)

1 Gire el dial de modo a modo de grabación de cinta.

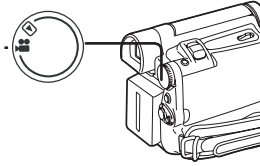

2 Presione el botón [PHOTO SHOT] en el modo de pausa de grabación.

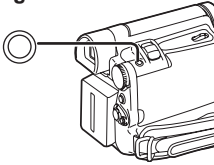

■ Grabación de una imagen fija en tarjeta  
(Photoshot)  
(Sólo para el modelo  
PV-GS12/PV-GS14/PV-GS15)

1 Gire el dial de modo a modo de grabación de tarjeta.

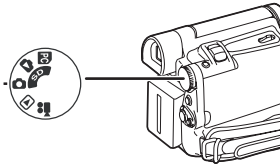

2 Presione el botón [PHOTO SHOT].

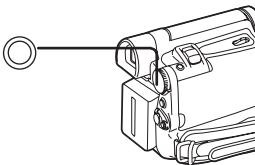

■ Reproducción de una cinta

1 Ajuste el interruptor [OFF/ON] ① a [ON].

• La lámpara [POWER] ② se enciende.

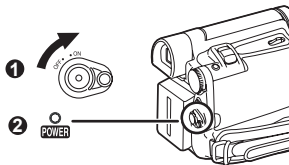

2 Gire el dial de modo a Modo de reproducción de cinta.

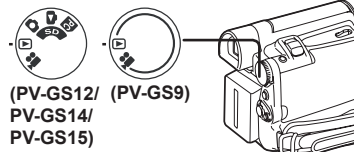

(PV-GS12/ (PV-GS9)  
PV-GS14/  
PV-GS15)

3 Presione el botón [◀] para rebobinar la cinta.

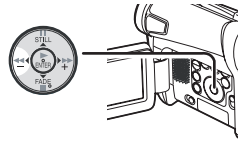

4 Presione el botón [▶] para comenzar la reproducción.

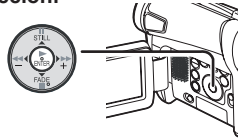

5 Para parar la reproducción.

• Presione el botón [■].

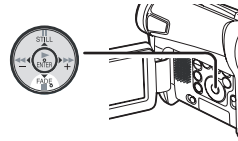

■ Reproducción de una tarjeta de memoria  
(Sólo para el modelo  
PV-GS12/PV-GS14/PV-GS15)

1 Gire el dial de modo a modo de reproducción de foto.

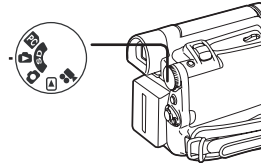

2 Comience la reproducción.

- ▶ : Comienzo de una presentación
- ▶▶ : Reproducción de la foto siguiente
- ◀◀ : Reproducción de la foto anterior
- : Parada de la presentación
- || : Pausa en la presentación

**Index****A**

AC Adaptor .....	15, 66
ArcSoft Software .....	55
Audio Dubbing .....	44
Auto Focus .....	71

**B**

Backlight .....	29
Black & White Mode .....	33
Blank Search .....	24
Built-in LED Video Light .....	26

**C**

Camcorder Accessory Order Form .....	74
Camcorder Accessory System .....	73
Charging the Battery .....	15
Cinema Mode .....	29
Condensation .....	66
Cue Playback .....	35
Customer Services Directory .....	78

**D**

Date/Time Indication .....	60
Date/Time Setting .....	23
Digital Effects .....	33
Digital Still Picture .....	25
Digital Zoom .....	27
DPOF Setting .....	41
Dubbing .....	45
DV STUDIO 3.1E-SE (Optional Software) .....	53

**E**

Erasure Prevention Slider .....	17
---------------------------------	----

**F**

Fade .....	28
Formatting a Card .....	42
F Number .....	32

**H**

Headphones .....	64
------------------	----

**I**

Iris .....	32
------------	----

**L**

LCD Monitor .....	19, 68
Limited Warranty .....	76
Lock Setting .....	41
Low Light Mode .....	30

**M**

Macro Close-up .....	27
MagicPix Function .....	29
Manual Focus .....	32
Memory Stop .....	71
Mirror Mode .....	33
Mix Mode .....	34
Mosaic Mode .....	33
Multi-Picture Mode .....	33

**N**

Negative Mode .....	33
---------------------	----

**P**

Photoshot .....	25
Picture-in-Picture Mode .....	34
Picture Size .....	39
Playback Digital Effects .....	38
Playback with Zoom Lever .....	36
Playback Zoom .....	37
Portrait Mode .....	30
Program AE .....	30

**Q**

Quick Start .....	26
-------------------	----

**R**

RapidFire Consecutive Photoshot ..... 26  
 Recording Check ..... 24  
 Recording Speed ..... 23  
 Remaining Battery Power ..... 59  
 Remaining Tape Time ..... 59  
 Remote Control ..... 14  
 Repeat Playback ..... 64  
 Request for Service Notice ..... 75  
 Review Playback ..... 35

**S**

SD Memory Card ..... 57  
 Self-timer Recording ..... 27  
 Self Recording ..... 26  
 Sensor tag ..... 16  
 Sepia Mode ..... 33  
 Shutter Speed ..... 32  
 Simultaneous Motion/Still Record Mode ..... 24  
 Slide Show ..... 39  
 Slim Mode ..... 33  
 Slow Motion Playback ..... 36  
 Solarisation Mode ..... 33  
 Sound Volume ..... 35  
 SP/LP Mode ..... 23  
 Spanish Quick Use Guide ..... 79  
 Sports Mode ..... 30  
 Spotlight Mode ..... 30  
 Still Advance Playback ..... 36  
 Stretch Mode ..... 33  
 Strobe Mode ..... 33  
 Surf & Snow Mode ..... 30

**T**

Time Code ..... 71  
 Trailing Effect Mode ..... 33

**U**

USB Connection Kit ..... 47

**V**

Variable Speed Search ..... 36  
 Video Head Clogging ..... 67  
 Viewfinder ..... 19, 68

**W**

Web Camera ..... 50  
 White Balance ..... 30  
 Wipe Mode ..... 34

**Z**

Zoom ..... 27  
 Zoom Microphone ..... 27

---

**Panasonic Consumer Electronics Company,**  
**Division of Matsushita Electric Corporation of America**  
One Panasonic Way Secaucus, New Jersey 07094

**Panasonic Sales Company ("PSC"),**  
**Division of Matsushita Electric of Puerto Rico, Inc.**  
Ave. 65 de Infantería, Km. 9.5 San Gabriel Industrial Park Carolina,  
Puerto Rico 00985



Printed in Indonesia  
LSQT0802 A  
S0104A1024